

13,778. Haefely, E. June 17.

Non-conducting coverings.—Paper pipes and tubes for purposes of insulation, particularly electric insulation, are made in an apparatus consisting of a removable drum z which can be rotated on the spindle b by worm gear. Above the drum is an angular pressure plate c which is supported by pins d in guide-slots e . The angle-plate hangs on a helical spring in the bracket f , can be adjusted by the screw spindle g , and is heated by steam, electricity, or, as shown, by gas jets from the gas pipes k . The tube is constructed by winding the paper once round the drum z , and then causing the drum to rotate while an insulating-material, such as mica plates, is fed in between the wound and unwound paper as indicated by the dotted line.

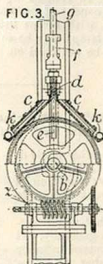

13,839. Theissen, C. June 18.

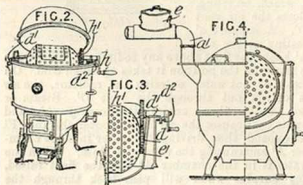

Heating liquids; boiling-pans.—In order to wash, as well as boil, clothes in a copper, a rotatable perforated drum is disposed in it. The drum may be removed and the vessel used for boiling or steaming substances such as cattle food. Figs. 2, 3, and 4 show one construction in which the drum, consisting of a central cylinder with convex ends, rotates on an axis resting in bearings d which are secured to supports d^1 held on the edge of the copper by screws or the like d^2 . The drum is rotated by means of engaging spur-wheels e^1, h^1 and a crank h . Its depth in the water may be adjusted by varying the length of the supports d^1 and using spur-wheels h^1 of different sizes. The drum and the copper are made of material unaffected by caustic solutions, and the drum is provided internally with ribs or the like to assist in cleansing the clothes. In another form, the bearings for the drum may rest directly on the sides of the copper, the drum being directly rotated by a crank.

Water for rinsing is heated by the waste gases in a vessel e , Fig. 4, resting on the flattened top of the smoke pipe a^1 or on a separate plate provided there.

13,900. Brewtnall, A. W. June 20.

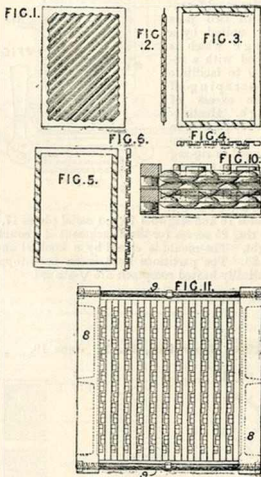

Heating gases and liquids.—Relates to surface apparatus, applicable as a condenser, steam generator, air-heater, water-heater, oil-cooler, or the like. Corrugated plates, Figs. 1 and 2, separated by distance frames or pieces, Figs. 3, 4, 5, and 6, are secured together so that the structure, Fig. 11, consists of plates and frames alternately. The plates, which have plain margins, are so superposed that the surfaces of the corrugations are in contact, or nearly so, and the corrugations on successive plates run in different directions alternately. The distance-frames may have orifices or serrations which serve as the inlets and outlets for the fluids, formed either at the ends as shown in Figs. 3 and 4, or at the sides as shown in Figs. 5 and 6. The frames are arranged so that one form alternates with the other as shown in Figs. 10 and 11. In this way, the liquids between which heat is transferred flow in directions which are inclined to one another. The plates and distance-frames are held together by end clamping-plates 8, which are drawn together by bolts or the like 9 so as to

make a tight joint between the margins of the plates and the frames. Packing-material, such as india-rubber or spun cord, may be placed in grooves in faced surfaces of the frames; or the faced surfaces may be covered with elastic backing-material.

13,922. Gelpel, W. June 20.

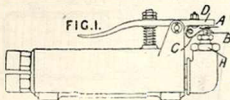

Steam traps.—Relates to steam traps of the expansion type, such as are described in Specifications No. 7860, A.D. 1893, and No. 21,571, A.D. 1894, and elsewhere, means being provided whereby the friction consequent on a tight stuffing-box is overcome without leakage, and the valve spindle is easily removed. The spindle B is provided with a button, pin, or collar A, which is held firmly against the stop or lever D by a spring C, preferably forked, attached either to the lever or to the frame of the trap. To remove the spindle, the collar H is unscrewed.

13,942. Le Brun, L. June 20.

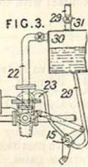
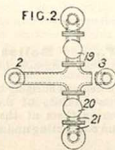
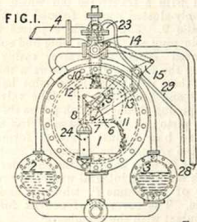

Heating buildings &c.—Relates to an oscillating device for automatically controlling and recording

the return of the condensation water from steam radiators &c. to the generator. In the reservoir 1, a box closed at both ends and divided diagonally by a partition rocks on the shaft 6. The walls 7, 8 are solid, but the other two are pierced by numerous large holes. The shaft 6 passes through the wall of the reservoir 1, traversing a stuffing-box, and attached to it is an arm with a counterpoise 13. The condensation water to be recovered passes along the pipe 4 and, falling upon the perforated side 10 of the box, fills up that half while the water collected in the other half is running out through holes pierced at 11. When sufficient water to counterbalance the weight 13 has entered, the measurer 5 rocks and the water escapes through holes pierced at 12. The counterpoise can be regulated to control the amount of water admitted into the measurer between each oscillation. Also attached to the shaft 6 is a system of levers operating the stop-cocks 14, 15, and to deaden the shock of oscillation an air check cylinder 24 may also be added. The three-way cock 14 in one position connects the small reservoirs 2, 3 with the boiler through the pipe 23, and in the other only permits connection between them and the condenser 23, which is itself connected with the reservoir 1. Fig. 2 shows the connections between the reservoirs 1, 2, 3 and the pipe 21 from the generator, through the non-return valves 19, 20. The live steam passing through the pipe 23 and into the reservoirs 2, 3 balances the pressure upon the valve 20, and the water in the reservoirs therefore runs into the generator. At the next movement of the cocks, the steam in the reservoirs 2, 3 passes into the condenser 23 and equalizes the pressure in all three reservoirs, whereupon the reservoir 1 empties into the reservoirs 2, 3. To accelerate the condensation and relieve the pressure upon the valves of the draining-devices which discharge the water into the pipe 4, a spray of cold water enters by the pipe 29 through the stop-cock 15. On the shaft 6 may be fixed an oscillation counter, so that the total volume of water supplied to the generator may be ascertained. Fig. 3 shows a modification of the arrangement of the cold-water supply pipe 29 in case the pressure in the condenser is too high to permit the admission of the cold water. The reservoir 30, placed slightly higher than the condenser 23, is connected with it by the pipes 22, 29. When condensation has occurred, the cold water may enter through the non-return valve 31 and fill the reservoir 30, the stop-cock 15 being closed. At the next movement of the levers, the steam admitted into the condenser and therefore acting upon the water in the reservoir 30 causes the water to enter the condenser as desired. Hence, whatever the pressure in the condenser, the same pressure acts in the reservoir 30 and the admission of the cold water is assured.

13,969. Riddle, H. S. June 20.

Heating by electricity.—Relates to means for electrically closing and heating vulcanizers for india-rubber &c., applicable also to other heating

processes. In Fig. 1 is shown apparatus for moulding and vulcanizing single-tube pneumatic tyres. The mould is made, preferably, of cast iron, and consists of two parts 10, closed and heated by means of the magnetizing-coils 14, 15, 16, 17. Closing is preferably affected by a direct current and heating by an alternating current. Fig. 3 shows a suitable arrangement where the mould is closed by means of the linkwork shown, actuated by a solenoid 27, heating being effected by coils 31, 32, preferably traversed by an alternating current which heats not only by ohmic loss but by hysteresis and Foucault currents. Rubber tubes are formed on a mandrel and heated either in coils or by a current passed through the mandrel itself. Fig. 9 shows an oven for vulcanizing or similar purposes made on these principles. The door is closed by means of coils 55, and the oven is heated by currents in coils 52.

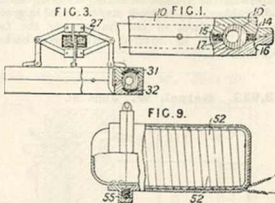

14,211. Day, P. J. C., and Steam Fittings Co. June 23.

Thermostats.—

Relates to thermostatically-operated valves for regulating and maintaining the temperature of water and other liquids or fluids in tanks or vessels. A flexible chamber *o* containing an expansible fluid, such as alcohol, acts on the valve *y* through a rod, piston, or plunger *v*, which moves fluid-tight in a cylindrical or other passage extending between the tank in which the chamber *o* is located and the valve casing. The plunger *v* engages with the screw-threaded portion of a plunger *q*, and is rotated relatively thereto, when, for instance, the apparatus is adjusted to operate at different temperatures, by turning a spindle 9. In the arrangement shown in Fig. 1, the chamber *o*, which is preferably of cylindrical form with annularly-corrugated ends or diaphragms, is held in a frame or cage *t* between a detachable cover or spider *n* and the head of the plunger *q*.

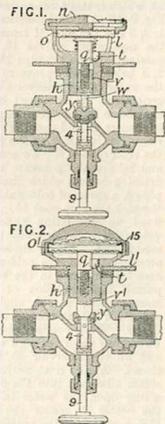

The plunger *q*, which is pressed against the chamber *o* by a spring, is prevented from rotating in the central passage of a cylinder *h* by any means, such as a longitudinal slot on the plunger *q* with which engages a projection *t* on the inner surface of the cylinder *h*. The lower end of the piston *v* has an extension *u* which engages with a recess in the valve *y*. The valve is allowed to oscillate slightly so as to fit its seat accurately, by providing the extension of the piston *v* with a transverse pin which fits loosely in transverse slots in the sides of the recess of the valve. An axial extension 4 on the underside of the valve is also provided with a transverse pin which engages a transversely-slotted socket formed at the end of the spindle 9. This spindle 9 passes through a removable plug so that the plug and spindle may be removed from the valve casing without disturbing the valve. Fig. 2 shows a modification in which there is only one loose joint between the spindle 9 and the piston *v*. The valve *y* has a central opening through which passes the extension 4 of the piston *v*. The piston *v* has a shoulder adapted to bear against a socket formed in the back of the valve. The expansible chamber *o* is clamped at its edge between the shoulder of a ring 15, which is formed integral with the cover, and a shoulder of the frame *t*, which is closed on its underside. The cover is of convex form, and is not in contact with the chamber *o*.

14,214. Simpkin, W., and Ballantine, J. B. June 23. Drawings to Specification.

Heating liquids.—In the dephosphorizing of iron ores, troughs containing a mixture of ore and liquid are heated by covering them at the sides and ends with partitions and conducting underneath waste furnace gases.

14,238. **Burdh, A. F.** June 23.*Heating liquids.*

—A surface apparatus is described as adapted for the condensation of exhaust steam but is stated to be applicable also for other cooling or heating purposes, such as steam generating or superheating, feed-water heating, or, according to the Provisional Specification, it may be used as a preliminary heater in connection with apparatus for purifying oil. A casing B is fitted with a

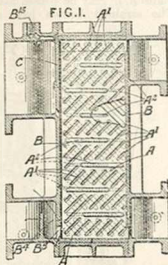

sheet A of aluminium or other metal, which is doubled upon itself to form two series of independent compartments. In some cases, a number of sheets connected together at opposite edges alternately may be employed in place of a single bent sheet. Stamped-up portions are formed in the sheet, of which the portions A¹ project into one series of compartments and the portions A² into the other series. In a steam condenser as shown, steam is admitted through a grid C, which protects the bends of the plate, into one series of chambers, the cooling-water being passed through the other series. The water of condensation escapes by the opening B² at the bottom, where a pocket B¹ is formed to prevent the escape of uncondensed steam. To facilitate the entrance of steam, the upper end of the steam compartments is somewhat enlarged. A cleansing-charge of soda or the like may be run into the steam compartments through the conduit B¹. When used for the other purposes mentioned, the heating-medium is conducted through one set of compartments, and the fluid to be treated through the other set.

14,395. **Townshend, E.** June 25.*Boiling - pans.*

Kettles and similar liquid-heaters are provided with false bottoms which furnish one or more horizontal spaces at the base of the boiler. In Fig. 1, a² shows the bottom proper of the boiler, which is made slightly concave, while two false bottoms c, d provide a horizontal space e which divides the boiler into two water-containing compartments a¹, a². The compartment e is furnished with a ring of discharge openings e¹, Figs. 1 and 2. Openings f admit the flame gases to the compartment e, and tubes g connect the water-containing compartments a¹, a². One of the tubes g extends up into the body of the boiler, thereby ensuring circulation of the water. In modifications, (1) two spaces e are provided, one above the other, and (2) the discharge openings e¹ are placed on the sides of the boiler.

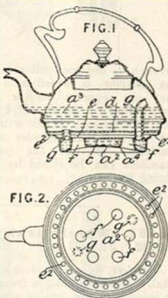

directly but serve to heat the air to be used in the bath. Fig. 2 shows a section of the heating-chamber. The hot gases pass through the tube 5 to the chimney 6, and thereby heat the air in the chamber 1. The

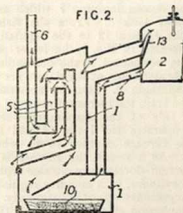

hot air rises to the chamber or bath 2, and on cooling returns to the heating-chamber by the pipe 8, being passed over the dish of calcium chloride 10 to dry it. Thus a continuous circulation is set up and the bath is supplied with hot dry air. In a modification, the cooled air is led back to the heating-chamber but passes up the chimney with the heating-gases. In this case, atmospheric air is sucked in over the calcium chloride, and is heated and fed to the bath.

14,420. **Mirtl, C.** June 27

Heating air.—Heating-apparatus for a hot-air bath is so constructed that the products of combustion of spirits, or other substance, are not used

14,467. **Beck, F.** June 29, A.D. 1903, [date applied for under Patents Act, A.D. 1901].

Heating water.—For increasing the rapidity of circulation of the water employed for heating

buildings, and for dealing with the generated steam without employing the usual expansion cylinder in the ordinary way, the steam is entrapped and is used for forcing back the supply

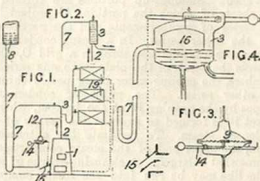

of cold water into the tank and for regulating the action of the furnace or other medium employed for heating the water. Fig. 1 shows a diagram of a system of hot-water circulation, Fig. 2 the chamber for entrapping steam, and Figs. 3 and 4 devices for using the steam for regulating the furnace by the use of the steam generated. The rising-pipe 2 from the boiler 1 is fitted with the trap 3 for collecting the steam and with the branch which, with a bend in it, takes the water direct to the radiators 19 without the interposition of a cylinder. From the pocket 3 extends the descending-pipe 7 which ascends to the cold-water tank 8. From the rising-pipe 2 stretches the branch 12 to the regulating-device shown in section in Fig. 3, the lower part of the device being connected to the descending-pipe 7. The two compartments of the device are separated by the diaphragm 9. On an accumulation of steam in the trap, the increased pressure acts upon the upper side of the diaphragm which, being depressed, operates the lever 14 and in consequence the furnace damper 15 to which it is connected. As a result, the furnace is checked. The diaphragm device may be also replaced by a piston in a cylinder, by a mercury regulator, or by other arrangements operating similarly. Instead of the diaphragm device, the float 16, Fig. 4, within the steam-trapping chamber 3 may be employed; or the float may be placed in a chamber directly dependent on the boiler.

14,482. Wheelwright, C. S., and Fiske, J. T. June 27.

Digesters for extracting oil and grease from garbage or offal by treatment with steam and water. Water is passed in from the pipe T, and the garbage through the cover A'. Steam is supplied by the pipes T', T' to a circular pipe T², which surrounds the lower conical end of the digester and enters under deflectors K by several pipes T'. Water, grease, and oil are forced upwards through a strainer formed by coarsely-perforated plates b, b', the plate b being furnished with large

teats c to prevent clogging. A layer of charcoal or other medium held between the other perforated plates a, a' may be placed between the plates b, b'. The strained liquids pass up the pipe C and

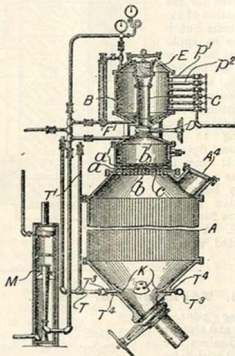

through a charcoal filter E, and fall over into the receiver B, which acts as a trap. When they are separated, water may be drawn off from below by the pipe F¹, and oil by pipes p¹, p², &c. Connections fitted with valves lead from the top of both digester and receiver to the condenser M, and the passage between the chambers can be closed by means of a valve D during discharge.

14,483. Wheelwright, C. S., and Fiske, J. T. June 27.

Digesters, for extracting oil from garbage or offal. The steam enters from the pipe P² through an injector at the top of the pipe P⁵, and passes down the pipe through a central heater D to the bottom of the digester. The heater D receives steam from the pipe P² through the connection P³, and it is fitted with a waste-steam pipe P⁴. The steam from the pipe P⁵ is partially condensed among the garbage, and oil and water are forced up through a strainer B, having hanging teats b, into a trap formed in a stand-pipe above the digester. The oil and water are withdrawn from the trap to a receiver T by the pipe P⁷, which is fitted with a clapper valve regulated by a weight on the arm W³. When cooking is finished, the steam entering by the pipe P⁵ is cut off, and water circulation to wash oil from the garbage is obtained by opening the valve of a return pipe P⁷, which connects the flow-pipe P¹¹ with the top of the

pipe P². Fresh water, if required, can be admitted to the pipe P³ from the pipe P¹⁴.

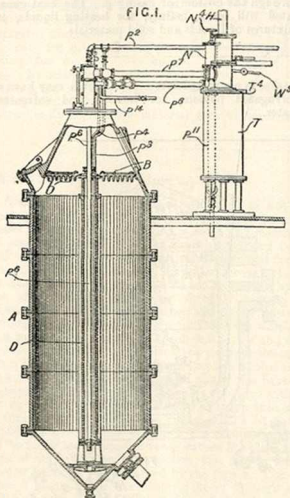

vessels in which substances are subjected to water treatment, for example, with a digester in which oil is extracted from garbage. The garbage is passed from the digester A to the straining-cylinder B through the connection N¹, and the water extracted is forced by a pump N¹ up the pipe N² to the top of the digester or of the cistern N².

14,709. Wheelwright, C. S., and Fiske, J. T. June 30.

Digesters.—Grease and oil are extracted from garbage or offal in a digester A, to which steam and hot water are admitted from pipes P, P¹ through a circular pipe P². Oil or grease and water rise through a strainer with hanging blades or teats, placed in the digester just above the inlet door B, and pass up through the connection J to the receiver H¹. The apparatus is fitted with glasses L, L¹, L², L³ to indicate the height of oil and water. A valve V, worked by a hand-wheel W, is placed between the digester

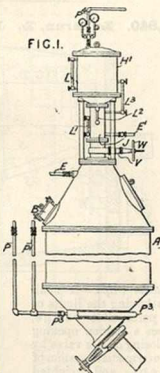

14,484. Wheelwright, C. S., and Fiske, J. T. June 27.

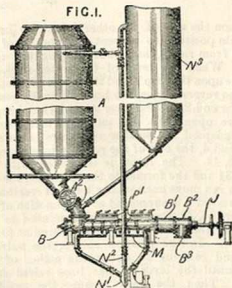

Digesters.—Straining-apparatus is combined with

and the receiver. Water can be blown off from the digester through the pipe E, and water and oil can be withdrawn from the receiver by the pipe E¹. Steam is passed off by the pipe P⁴.

14,750. Lang, A. June 30.

Heating by chemical action.—Relates to means for igniting substances having high ignition points in apparatus for heating by the reaction of such substances. A succession of materials d, b, c is employed, having different ignition points and heats of combustion, and one ignites the other in series. The material c consists of a mixture of aluminium or magnesium with metallic oxides, above which is a layer b of material consisting of magnesium with potassium chlorate. The ignition is started by



setting fire to a celluloid protecting-plate *d* with a match, and the materials are successively ignited and finally burn through a conical magnesium cap *a*, and ignite the material *e* contained within a casing *g*. The material *e* may consist of aluminium

or magnesium with metallic oxides. A copper disc *f* prevents the material *e* from burning through the bottom of casing *g*. The heat generated will serve, mainly, for heating liquids, or mixtures of liquids and solid materials.

14,757. Thwaite, B. H. June 30.

Heating water.—In a plant for the purification and cooling of blast-furnace gases, the top of a

washer is converted into a tank, which may have a corrugated bottom, for heating and softening water.

14,840. Le Brun, L. July 1.

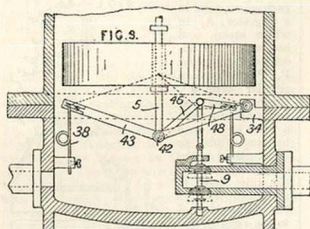

Steam traps.—A float, on attaining the limits of its permissible range, causes a sudden opening or closing of the valve by an intermediate system of detents and weighted levers. The double-seated balanced valve 10, Fig. 1,

supported by the rod 9 passes between the double stops 6, 7 are attached at the required positions. The rod 5 is jointed at 8 to the weighted lever 12, which is heavily loaded at 13, 14 and rocks on the spindle 11. The valve-rod 9 is attached to the lever 24, the end 21 of which is caught by one or other of the two detents 16, 18, placed on either side of the lever 12. To ensure an equal upward and downward thrust of the float, it is of special construction, being made of poplar wood and coated with a thin metallic covering, its specific gravity being thereby about .5. Water enters the chamber through the pipe 1 and the opening 2, the passage 3 serving to equalize the pressure. In the position shown in Fig. 1, the valve is open and water is escaping through the pipe 29. When the float reaches the stop 6, it causes the lever 12 to overbalance and take up the position shown in Fig. 2. The stud 15 strikes against the arm 16 and so releases the lever 24. The rod 9 falls, thus closing the valve, being further assisted by the stop 6 striking against the valve cover 30. Meanwhile, the stud on the further side of the lever 12 has

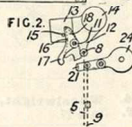
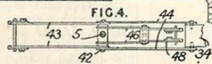
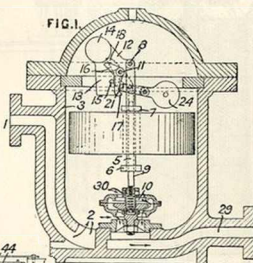

acted upon the arm of the other detent, so bringing it into position to prevent the end 21 of the lever 24 from rising, and thus keeping the valve closed. When the level of the water rises, the float acts upon the stop 7, and the levers and detents act in the reverse order, the hook 17 finally resting under the end 21 of the lever 24 and thus keeping the valve open. In the modified arrangement (better adapted for smaller chambers) shown in Figs. 3 and 4, the end of the rod 5 is jointed to the two levers 46, 48, the former being jointed to the rod 5 at 42 and the latter to a spring 38, the end of which can move horizontally but not vertically. The valve-rod 9 is supported at the junction of the two levers 46, 48, the former being jointed to the rod 5 at 42 and the latter to a spring 38, the end of which can move horizontally but not vertically. The valve-rod 9 is supported at the junction of the two levers 46, 48, the former being jointed to the rod 5 at 42 and the latter to a spring 38, the end of which can move horizontally but not vertically. In the position shown, the valve is closed and remains so under the action of the springs until the lever 44 has been raised sufficiently. Then the rods assume the position indicated by the dotted lines and the valve is opened.

14,869. McWhirter, C. July 2.

Heating by steam circulation; heating air.—A combined apparatus for heating wood for creosoting, chemically treating, or disinfecting fabrics, and subsequently drying the material treated consists

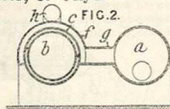

of an oven or boiler *b* surrounded by a steam jacket *c*, which is in turn wholly or partially surrounded by an air jacket *f*. A drying-chamber *a* is connected by passages *g* with the air jacket, which is supplied with air through an inlet *h*, the air either passing through the jacket and chamber and escaping at an outlet in the end of the chamber *a*, or being circulated by a fan or the like. The drying-chamber may be arranged so that a portion of its surface is formed by the external surface of the vessel *b*.

14,907. Grove, D. July 2.

Heating by water circulation.—Relates to hot-water heating-systems in which the hot-water vessel for supplying the system is heated by means of steam fed through a coil, the object being to utilize the hot waste water from the steam coil for promoting the circulation of the water through the system. Water, which is heated in the vessel *c* by the steam coil *d*, circulates through heating-pipes 1, 3, 4. Waste water from the coil *d* flows through a steam trap *i* into a tank *b*, from which it is pumped by a pump *p*, through a pipe *e* and a counter-current heater *g*, heated by exhaust steam from the pump, and finally flows through a pipe *w* to an expansion vessel 5, arranged above the heating-system. The expansion vessel is provided with an outlet *r*, which allows water to overflow into a channel *r*, in consequence of which the accumulation of water in the expansion vessel causes the circulation of water through the system, and allows the coolest water to be discharged by the pipe *k*. Condensed steam from the heater *g* flows through a pipe *o* to the tank *b*. The action of the pump *p* may be intermittent or continuous, and may be automatically controlled by arranging a float *s* in the tank *b*, and attaching a rod *t* to the float for actuating the valve *h* which supplies steam to the pump.

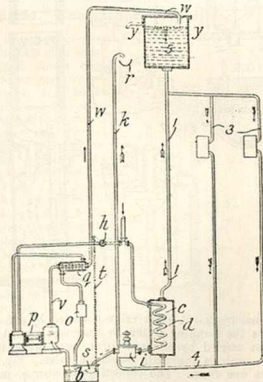

14,989. Töbelmann, C. July 4.

Heating liquids; heating buildings &c.—To increase the circulation in boilers, and in installations for heating by hot water and other liquids, steam at a relatively high pressure is generated by the arrangement used for heating the water or liquid, and is discharged into the heating-circuit. Fig. 1 shows the arrangement as applied to one form of water-tube boiler, and Fig. 3 to a hot water heating-installation. As regards Fig. 1, the small water-tube boiler 8, situated immediately over the furnace, is provided for the supply of steam by the pipe 11 and mouth 5 to the extension 6 of the front header 2. The steam supply may be cut off from the pipe 11 by the valves 12, 13. The water dripping from the steam pipe 32 may be caught by a pan for feeding the auxiliary boiler, or pure water alone may be used. The supply is

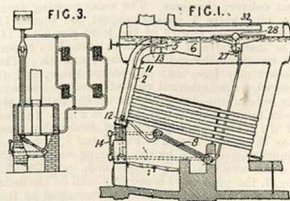

made up by the float 23 opening the valve 27 in the pan. The gauge glass 14 may be provided. In the arrangement shown in Fig. 3, the steam is injected into the widened portion of a vertical pipe. The injector could be equally well arranged in the discharge pipe.

15,085. Neilson, R. M. July 6.

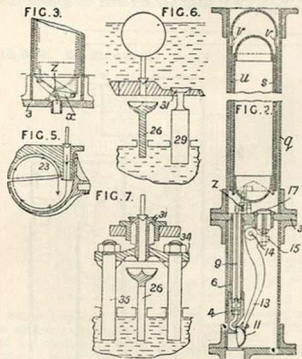

Steam traps.—A pilot valve actuated by a float allows the escaping water to impinge against a bucket carried by one arm of a lever, while the other controls the main discharge valve. Fig. 2 shows one form. The collecting-chamber *g*, preferably of cylindrical shape, contains a float *s* with a counterweight *u*, fitted with pressure-equalizing holes *v*, attached as shown in Fig. 3 to the opposite arms of a lever pivoted at *x*. The small valve 4 is actuated by the rod 9 fixed to the arm *x* of this lever near the fulcrum. The tube 6 containing the lever 4 and its controlling-rod is screwed steam-tight into the partition 3 dividing the collecting and delivery chambers. The water escaping from the pilot valve 4 strikes against the bucket 11 attached to the arm 13 of the lever pivoted at 14. The main valve 17 is therefore opened by reason of its connection with the short arm 15. The bucket may have any convenient shape, and, if desired, a hemispherical recess 23 may be made in the side of the chamber to cause the water to act twice upon the bucket, as shown in Fig. 5. Instead of the lever 13, the principle of Brahma's press may be used, as shown in Figs. 6 and 7, 26 being a plunger acted upon by the escaping water and 29 the ram which is fixed to the main valve 31. In Fig. 7, the pilot valve is shown placed on the main valve, and the double ram 35 is connected to this main valve by the cross-plate 34.

15,129. Burdh, A. F. July 6.

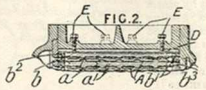

Heating water and other liquids.—Chambers are constructed of sheets of copper or other metal arranged vertically and parallel to one another, the hot and cold fluids traversing the alternate spaces and receiving a churning motion. The apparatus is especially applicable as a steam-engine condenser.

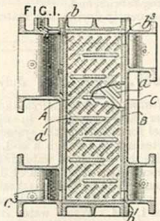

In the form shown in Figs. 1 and 2, separate sheets A are placed vertically with distance-pieces B in a casing C. On the sides of every other chamber thus formed, obliquely-placed corrugations *a* or isolated nodules are stamped, while on the other sides horizontal ridges *a'* are arranged with alternately wide and narrow spaces between their ends and the side walls of the casing C. The steam or other heating-medium is admitted by a conduit and suitably-arranged openings in the case and frames at *b*, and passes down through the chambers containing the corrugations *a* while water or other cold fluid enters at *b'* and ascends the other chambers, receiving a churning motion due to the ridges *a'*, and escaping at *b''*. The baffle C³ prevents the escape of steam by trapping the condensation water. In one modification, the chambers may be formed of one sheet bent over on itself several times, or of several sheets each bent once and placed side by side. Fig. 2 shows in plan how the joints of the distance-pieces and sheets may be rendered watertight by means of the screws B and plate D.

15,235. Wheelwright, C. S., and Fiske, J. T. July 7.

Digesters for extracting oil and grease from garbage or offal by treatment with steam and water. Water is passed in from the pipe T, and the garbage through the cover A. Steam is supplied by the pipes T', T to a circular pipe T'', which surrounds the lower conical end of the digester, and enters under deflectors K by several pipes T'. Water, grease, and oil are forced upwards through a strainer formed of coarsely-perforated plates *b*, *b'*, the plate *b* being furnished with large teats *c* to prevent clogging. A layer of

charcoal or other medium, held between other perforated plates a, a' may be placed between the plates b, b' . The strained liquids pass up the pipe C and through a charcoal filter E, and fall

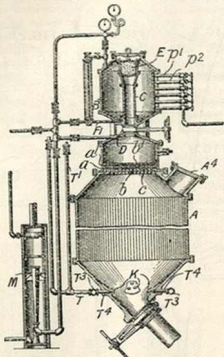

over into the receiver B, which acts as a trap. When they are separated, water may be drawn off from below by the pipe F¹, and oil by pipes P¹, P², &c. Connections fitted with valves lead from the top of both digester and receiver to the condenser M, and the passage between the chambers can be closed by means of a valve D during discharge.

15,271. Kermode, J. J. July 8.

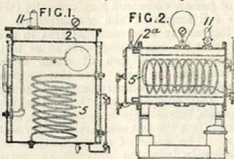

Heating liquids.

—Relates to apparatus for heating liquid fuel by steam, water being employed to prevent an undue rise of temperature. The steam (live or exhaust) is passed through a coiled pipe 5, which may be immersed in the

INDUSTRIAL MUSEUM

FIG. 3.

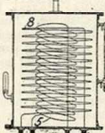

oil as shown in Fig. 1, or in the water as shown in Figs. 2 and 3. With the arrangement shown in Fig. 1, a water jacket surrounds the oil vessel. In Fig. 2, the oil vessel is shown as annular, surrounding the water vessel. In the arrangement shown in Fig. 3, the oil is passed through an outer coil 8, surrounding the steam coil and immersed in the heated water. Filtering-apparatus 2, Fig. 1, or 2^a, Fig. 2, may be fitted to the apparatus. The pressure of the oil may be regulated by a relief valve 11, and its level by a float valve as shown in Fig. 1. Fig. 2 shows the apparatus mounted above the oil-supply pump.

15,339. Engleitner, F. July 9.

Heating water.

Consists of a combined steam condenser and water-heater for boiler feed and for other purposes. Steam enters at the gland 9, Fig. 1, and passing through the space between the tubes 1, 2 leaves the apparatus at the gland 11. The water, entering the piece 13, is divided into two streams, one of which flows between the tube 1 and the outer casing 7, and the other between the tubes 2, 5. At the bottom of the tube 5 is a stopper, as shown. The water leaves the apparatus through the piece 14. In a modification, a number of tubes are combined in one casing and the inner tube 5 is dispensed with. The steam flows through the space between the tubes 1, 2, and the water passes through the tubes 2 and around the tubes 1.

FIG. 1.

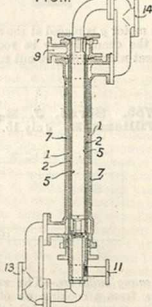

15,448. McLachlan, J. C. July 11. *Drawings to Specification.*

Heating water.—Water for use in connection with gas engines and for other purposes is heated by exhaust steam and by the heat of the exhaust gases from the gas engine.

15,576. Funke, H. M., Funke, M. P., and Funke, E. G. July 12.

Solar heat, utilizing.—Solar heat is used to create a current of air by which a reciprocating engine or

turbine is driven. The air is heated by the sun in a broad channel *b* situated on the south side of a hill and terminating in a tunnel *a* and chimney *e*.

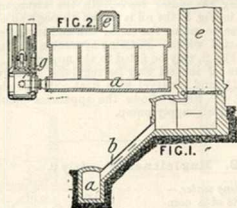

The motor *g* is placed at the entrance to the tunnel, and the channel may be roofed by an absorbent of heat which will give out energy after sunset.

15,755. Serné, J. B., Serné, L., and Williams, E. July 15.

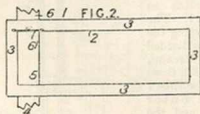

Heating buildings.—The waste combustion products from a cooking or other range, or other heating-apparatus, are led into the flues 3 round the top and ends of a closed chamber or hot-closet 2 in an outer chamber 1. A sliding damper 6¹ may be drawn out so as to open a flue 5 passing straight to the chamber 2 and connecting the flues 4, 6. The front of the chamber 2 is fitted with two doors, and baffles and dampers may be fitted.

15,759. Morison, D. E. July 15.

Heating water.—Relates to tubular surface apparatus which is divided into communicating compartments containing parallel sets of water tubes and adapted for condensing steam and heating water. Several forms of surface condensers are shown. Figs. 1, 2, and 4 show one form suitable for use when under a vacuum. To ensure an even distribution and flow of steam in a direction at right-angles, or nearly so, to the tubes, steam is admitted to the first of the compartments through a steam-distributing chamber *m*, which gradually increases in cross-sectional area from an inlet, approximating in cross-sectional area to the exhaust pipe connected thereto, to an

outlet *d* extending approximately the entire length between the tube-plates. At the opposite inlet and outlet sides of the compartments, and adjacent to the ports *d* connecting them, tubeless

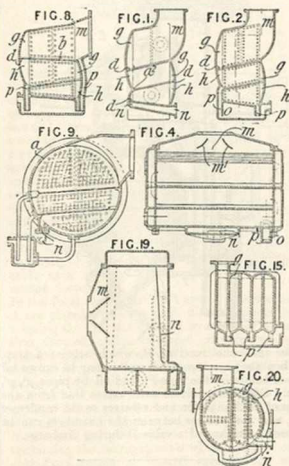

spaces or passages *g* extend longitudinally throughout the full length of the compartment. These spaces increase in cross-sectional area in a direction towards the connecting-ports, so as to lessen the resistance to the flow of steam from one compartment to the next. For this purpose, the outer walls of the compartments are preferably curved. The compartment, through which the steam passes, successively decrease in size, air being drawn off from the last compartment through the outlet *n*. The water of condensation is led off simultaneously from the different compartments through drain passages *p*, leading to a hot well *o*, as described in Specification No. 2842, A.D. 1904. Guide-plates *m*¹ may be provided in the distributing-chamber. The upper diaphragm *b* may be provided with a number of guide-ribs arranged to form converging drain passages leading to a gutter *a*² at the lower end of the next diaphragm. The diaphragms may be parallel; or they may be inclined in opposite directions, as shown in Fig. 8, and separate drain passages provided from each compartment. Fig. 9 shows a lighter construction of apparatus suitable for use on warships or turbine steamers. The casing *a* is circular, and each compartment is provided with a separate drain

passage. The air is withdrawn through a number of passages *n* connected to a common pipe so as to promote a uniform outflow of air. Or the outlet end of the last compartment may be provided with a single air-outlet branch, and a partition provided, between the lower edge of which and the casing is an opening extending the full length of the compartment. Fig. 15 shows a modification working at atmospheric pressure, suitable for use as a condenser in connection with steam winches on ship board, and also as an exhaust feedwater heater. The compartments are arranged side by side so that the spaces *g* are at the top and bottom alternately. A drain pipe *p* leads from the lowest part of each pair of compartments to a hot well. Figs. 19 and 20 show a further modification in which the casing is circular and the condensing-compartments vertical. The steam expansion chamber *m* and the air outlet *n* are arranged at the sides of the casing so that the steam flows horizontally between the pipes.

15,794. Morison, D. B. July 15.

Heating water.

Relates to apparatus for cleansing and condensing steam and heating water, especially applicable for the treatment of the exhaust steam from steam winches and steering and other continuously-running auxiliary engines. The apparatus may also be employed for heating feedwater or sea-water for baths. A steam-separating chamber 2, provided with steam-distributing and oil and water separating and collecting devices, is in direct communication with the condensing-chamber, or the first of a series of communicating condensing-chambers 8, through a steam-outlet passage or passages 7, which extend practically the entire length of the chamber 2. The chamber 2 and the chamber 8, which may be any type of surface or direct-contact condenser or heater, are embodied in one structure, as shown in Fig. 5. The passage between the separating-chamber 2 and the condensing-chamber is preferably formed in a division wall common to the two chambers. The separating-chamber is fitted with a removable cover 4, on the inner surface of which are oil and water separating and collecting devices.

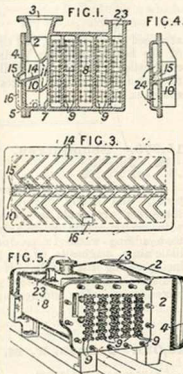

As shown in Figs. 1 and 3, these consist of one or more upwardly-inclined division plates 10, above and below which are inclined zig-zag or straight grooves formed by ribs 14. When the cover is in

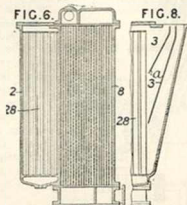

position, these ribs bear against inclined division ribs 11 carried by the rear wall of the separating-chamber. Steam admitted by the inlet 3, which may be provided with distributing-plates, thus follow a zig-zag path or its way to the collecting-chamber 5. Part of the separated oil and condensed water is directed by the plate 14 to a transverse channel 15, which communicates by a passage 16 with the chamber 5. The oil and water are drawn off from the chamber 5, while the steam passes through the opening 7 and over the successive sets of water tubes 9 to the outlet 23. In a modification, applicable to apparatus for the treatment of dry steam, the cover is provided with hollow water channels 24, between which the drain channel 15 is located, as shown in Fig. 4. Figs. 6 and 8 show another arrangement in which the steam flows in a horizontal direction through the chambers 2, 8, which communicate by a passage extending the length of the chamber 8. The chamber 2 is provided with separating and collecting devices, consisting of metal bars 28 of angular section, which are held in place by a top-plate. The stem inlet 3 is fitted with inclined distributing-plates 3°. Where the auxiliary or winch condenser is not usually in use, as at sea, the exhaust steam may be passed through the apparatus on its way to the condenser of the main engines. The water supply is so arranged that the apparatus serves only as a cleanser. When used as a feedwater-heater, the heated water of condensation may be drawn from any compartment which is free from oil. If sea-water passes through the water-tubes of the condenser, it may be used as bath water. According to the Provisional Specification, the removable cover of the separating-chamber may be provided with separating and collecting devices comprising rows of separate vertical baffle-plates which are inclined to the cover and rows of Λ -shaped baffling devices. The lower edge of each of the guide-plates carried by the inner wall of the separating-chamber terminates between a row of inclined, vertical baffle-plates and the next adjacent lower row of angular baffles. The cover may also be formed

in two parts. The outer portion may be in the form of a flat plate provided on its inner side with ribs extending into V or other shaped recesses of the inner part, so as to cause the water to follow a zig-zag path through the cover. Reference is made to Specification No. 2842, A.D. 1904.

15,840. **Helas, C.** July 16.

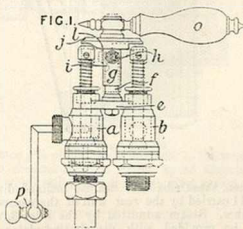

Heating water.—The gas valve *a* and water valve *b* of a water-heater are controlled by a single handle *o*, to which a cam-plate *j* having inclined surfaces *l* is attached. The surface controlling the water valve has a slight lead, so that the water valve is depressed first. The plate *j* is supported by a socket *g* on a pin *f* which is formed with a spiral groove *i* in which a screw *h* works, thus giving additional means for depressing the valves. The gas is ignited by a pilot burner *p*.

15,872. **Vlarmé, G.** July 16. *Drawings to Specification.*

Heating by electricity.—The regulating-resistance of an arc lamp, consisting of a wire strung with beads and wound into a coil, may be enclosed in an asbestos or like case and used as a heating-appliance.

15,875. **Waldaur, A.** July 16.

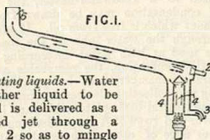

Heating liquids.—Water or other liquid to be heated is delivered as a sprayed jet through a nozzle *2* so as to mingle with, and deflect, the hot gases evolved in a combustion chamber *4*. In Fig. 1, the heating-chamber is shown in the form of an inclined cylindrical vessel. The heated

15,795. **Bodmer, E. H. Rieter.** July 15. *Drawings to Specification.*

Non-conducting compositions.—Consists of a mixture of asbestos or similar material and Portland cement.

liquid runs into a chamber surrounding the combustion chamber, whence it is drawn off by a pipe *3*. In a modification, Fig. 3, the nozzle is

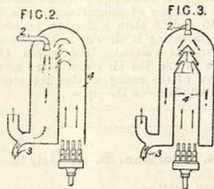

arranged above the cap, and the inclined extension of the heating-chamber is dispensed with. The combustion chamber and water-heating chamber may also be arranged vertically, side by side, as shown in Fig. 2.

15,979. **Schmidtgen, W., and König, M.** July 19.

Non conducting compositions, which are fire-proof, and firmly adhere to objects covered therewith, are made by mixing infusorial earth with textile waste, preferably short-fibred, and then adding water to produce a paste, with a little alum, magnesite, or the like, and thoroughly incorporating the whole. If desired, the earth and fibre may be separately put into water and mixed therein after adding alum or the like.

16,061. **Cannon, T. M.** July 20.

Footwarmers.—Covers of felt or similar material are attached to footwarmers by means of holes which button over studs placed in recesses in the bottoms or sides of the warmers. In a modification, screws fixed to the cover are adapted to enter plugs of wood fixed in holes or sockets formed in the side of the warmer.

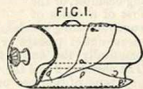

16,076. **Bushell, W. H., and Tomalin, L. R. S.** July 20.

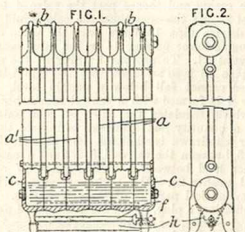

Heating buildings &c.—In a radiator, the water or other liquid, contained in the lower tube or chamber *c*, is heated by a gas or oil burner *f*, arranged so that the flame plays only on one end of the chamber. The vapour rises in the tubes *a*, which are immediately above the flame, and passes into the upper tube or chamber *b*, where it expands. It then passes down the colder tubes *a* and is condensed. The apparatus is hermetically closed. A trough shaped protector *h* is provided for the burner.

16,423. **Electric Equipment and Securities, Ltd., and Ruzicka, C.** July 25.

Heating by electricity.—Resistances are made from mixtures in various proportions according to requirements, of one or more metals or of one or more metallic compounds or alloys, such as carbonates, oxides, or chlorides, with one or more powdered stones or minerals such as quartz sand, soapstone, felspar, or limestone, and a suitable clay such as slate clay or bauxite, with the addition, unless already present, of one or more metallic salts. The compound is worked with a suitable liquid into a paste from which the required article may be moulded or pressed, and after being dried and baked it is heated in a reducing-furnace to reduce the metallic compounds. Or the paste may be dried, and then fused and either poured into moulds and afterwards treated in a reducing-furnace, or *vice versa*. The articles are provided with contact-pieces, and may be glazed as in the case of ordinary cooking-appliances. The following is a suitable composition for an electric radiator:—nickel powder 35 parts, wolfram powder 11 parts, nickel oxide 15 parts, silicon powder 2 parts, calcium felspar 4 parts, slate clay 15 parts, quartz 2 parts. The material may be used for electric cooking-apparatus, electric soldering-irons, electric stoves and radiators, and other appliances.

16,442. **Monteagle, R. C., and Vynne, E. Mann.** July 25.

Heating air, water, &c.—The tubes of boilers, condensers, evaporators, or other tubular apparatus in which heat is transmitted from one fluid to another are formed with spiral corrugations of considerable depth. Figs. 1 and 2 show an outside view and cross-section respectively of a tube thus formed.



16,446. **Rodriguez, E.** July 25.

Steam traps.—

The expansion and contraction of a pipe *a*, of copper or any other metal highly sensitive to change of temperature, controls the action of the lift-valve *n*, through which the condensed water is forced. Steam enters the trap through a separator *b*, shown in section in Fig. 3, and is deflected by the baffle-plates *c* so that the condensed water is thrown down the pipe *a* into a spherical vessel *d*, secured to the bottom of the pipe. As the vessel and pipe become filled with water, the pipe cools and contracts, and the rods *k* at its sides, engaging with the levers *l*, lift the valve *n*, thus allowing the water to be forced, (through the internal tube *f*), out of the apparatus by the steam pressure. When steam again fills the pipe *a*, it becomes heated and expands, thus permitting the valve *n* to fall. The bottom of the water-delivery pipe *f* is provided with a strainer *s*, and has, at its upper part, a control cock *g*. The valve and valve box *n*, and also the levers *l*, may be attached to the lower vessel *d*, and the rods *k* secured to the head *b*.

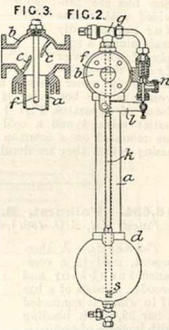

16,469. Chambers, C. July 26.

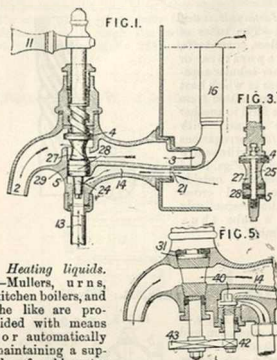

Heating liquids.
 —Mullers, urns, kitchen boilers, and the like are provided with means for automatically maintaining a supply of cold water from the water-service pipe under pressure to the muller, or other vessel, as the hot water is withdrawn. In one form of apparatus, Figs. 1 and 2, a hot-water outlet valve 4 and a cold-water inlet valve 5 are mounted on a common spindle in the valve casing so that they are simultaneously operated by

a handle 11. On the handle 11 being turned in one direction, the hot liquid flows out through an upturned pipe 16 to an upper passage 3 in the valve casing and thence past the valve 4 to the outlet 2. At the same time, the cold liquid from the service pipe 13 flows past the valve 5 and through a lower passage 14 in the valve casing to an outlet 21. To prevent burning of the vessel, the pipe 16 is so arranged that the liquid in the muller cannot fall below a certain level. The valve 4 is formed with a central removable plug 24 which regulates the inlet of cold water so that a quantity just sufficient to replace the hot water withdrawn is admitted. On the spindle 25, Fig. 3, between the valves 4, 5, is fixed a packing-washer held between a distance-piece 27 and a metal washer 28. The packing-washer works in the cylindrical part 29 of the valve casing. In a modification, a plug, which fits in a tapered part of the valve body, has cross-passages so arranged that, when the plug is turned to one position, the hot water flows through the cross-passages while the cold water flows through an inlet at the bottom of the plug and out through a side outlet into the passage in the valve body leading to the muller. In another arrangement, Fig. 5, the plug of the hot-water cock 31 is continued through a stuffing-box or the like at the bottom of the cock body, and is geared through pinion wheels 43, 42 to the spindle of a screw-down valve 40 located in the cold-water passage 14, so that both valves are simultaneously operated. According to the Provisional Specification the flow of cold water is regulated by a screw-down valve or other regulator located in the cold water inlet pipe. Preferably, the packing on the valve and spindle between the valves consists of a cup-leather.

16,634. Tolhurst, E. T., and Wilson, W. Aug. 3, A.D. 1903, [date applied for under Patents Act, A.D. 1901].

Thermostats.—A thermostat, used in a combined incubator and brooder, consists of a bar 37 to which is connected a bar 39, which, bending with increase of temperature, regulates the position of the damper 45 by means of the link 42 and lever 40. Hot gases are derived from a lamp at the end *g* of the pipe 30, the part passing away by the branch *h* being used for heating the apparatus. The volume of gas so used depends on the position of the damper 45. The lever 40 is adjusted by means of the nut 13.

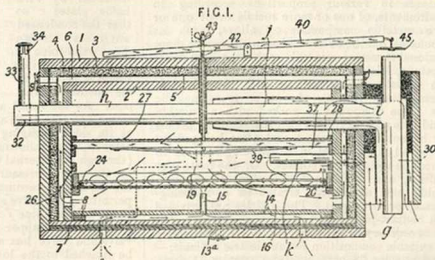

16,689. Tuckfield, C., and Garland, W. G. de F. July 29.

Heating liquids.

—Water, sewage, or the like is purified by being heated in a cylinder B, thence passing to a settling-tank F, and returning again to the cylinder B to give up its heat to the infowing liquid. The cylinder B, provided with tubes as shown in the Figure, is supported inside a vessel A, which is fitted with a steam coil C. The liquid enters at D, ascends the tubes in the cylinder B, and, after being heated by the coil C, passes to the settling-chamber F. It then enters the interior of the cylinder B and escapes at E, giving up some of its heat to the liquid ascending the tubes. It is stated that the force of the issuing fluid may be utilized to aid in working a hydraulic engine turbine, or the like for pumping in more liquid at D. The Provisional Specification states that a thermostat may be employed to prevent any liquid from escaping until the requisite temperature has been attained.

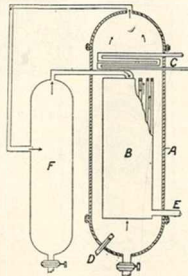

passes upwards through all the tubes in series. The water circulates from the bottom of the tank through the pipe *f* to the motor cylinder, and returns to the top of the tank through the pipe *h*, radiator, and pipe *i*. The ends of the radiator are formed by casings *e* fixed to the tube-plates and covering the whole of the small casings. The pipe *i* may be replaced by two pipes connecting the radiator and tank to another tank. The crinkled plates or gills may be of the circular form shown in Fig. 2 or of the rectangular form fitted to two or more tubes as shown in Fig. 7.

16,822. Böhm, H. July 30. *Drawings to Specification.*

Non-conducting coverings for cans containing preserved food and other substances are formed of two encircling pasteboard sheets, of which the inner is corrugated and secured to the outer one, which is smooth.

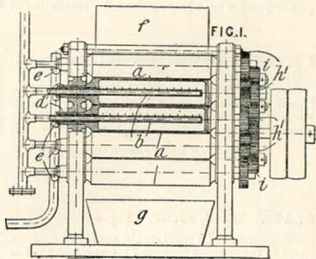
16,825. Magniez, P. F. E. Aug. 17, A.D. 1903, [date applied for under Patents Act, A.D. 1901].

Heating by water circulation.—In the preparation of chocolate paste and the like, the paste is heated or cooled by passing between several pairs of hollow metal rollers *a* arranged one above the other and revolving at the same speed. The rollers are heated by water supplied by perforated pipes *b* extending inside the rollers, the water escaping through outlets *d* into collectors *e* which conduct it to a reservoir where it is heated for re-use. The paste is fed from a hopper *f*, and received in a trough *g*.

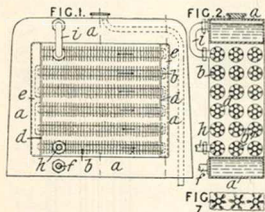
16,730. Bartlett, J. July 29.

Heating buildings &c.—Relates to a radiator primarily intended for cooling the circulating water in a motor car, but applicable also for heating purposes. In the arrangement shown in Figs. 1 and 2, the radiator is mounted within the tank *a*, and consists of a number of tubes *b* fitting into tube-plates *d*, the ends of adjacent tubes being bridged over by box-like casings, so that the water

16,858. Peter, O., and Racoszyn, H. von K. Aug. 2.

Heating air.—An apparatus for drying the hair is shown in transverse and longitudinal section elevation by Figs. 2 and 3 respectively. A current of air is drawn by a motor-driven fan 14 through an aperture 16 and an annular space 15 formed within the non-conducting walls 7 into a chamber 11, containing a number of electric glow lamps 12. After circulating round the lamps, the heated air passes into the passage 8, whence it flows into the scoop 4 in which the hair is laid, or through a flexible pipe attached to the nozzle 5. The motor 3 and lamps 12 are in parallel circuits, but a switch 20 is so arranged that the motor may be run without the lamps. The speed of the motor is regulated by an adjustable resistance operated by the lever 24. The passage 8 may be provided with sand-filled diagonal tubes 19. The apparatus is supported upon a telescopic stand.

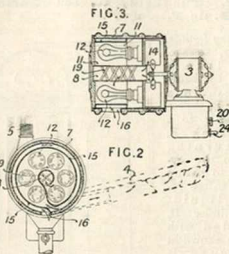

16,934. Lake, H. H., [Jewell, W. M.] Aug. 2.

Heating water.—Relates to a method of purifying water in boilers by the use of an insoluble reagent, so as to prevent foaming or priming. Barium carbonate in the form of witherite is preferably used. It is added to the water as a finely-ground powder, and is kept in suspension by circulation or

agitation of the water, chemical action being induced by electrolysis. If sodium sulphate is one of the impurities, magnesium or calcium chloride is added, unless one of these substances is already present. If the last-mentioned substances are in excess, a soluble sulphate, for example magnesium sulphate, is added. The precipitates are allowed to settle or are removed by filtration.

16,940. Müller, G., and Jarck, E. Aug. 2.

Non-conducting coverings and compositions.—The ingredients, consisting of clay, asbestos, silicious marl, vegetable fibres (rendered fireproof by treatment with aluminium sulphate), and ground

cork, and sometimes starch flour, are well mixed with water, and yeast is added to render the mass elastic and spongy. The composition may be applied directly to the surfaces to be covered or compressed in suitable moulds to form insulating-shells for boilers, steam pipes, &c.

17,103. Ward, M. W. Aug. 4

Thermostats.—To regulate the supply of cooling-water to the cylinder jackets of internal-combustion engines, a bulb containing mercury enclosed in a metal case, as shown in Fig. 2, is inverted in the cylinder jacket. The mercury as it rises makes contact with the wire shown connected to the right-hand terminal, Fig. 2, and completes the circuit containing the battery K and coil J shown in Fig. 1. The coil J, when excited, attracts the metal bar F and completes a second circuit containing a current generator E and coil D; the coil D attracts the solenoid C and opens the water-supply valve A. If a series of cylinders are cooled, electric bells may be placed in the smaller circuits to act as indicators in the event of faulty circulation.

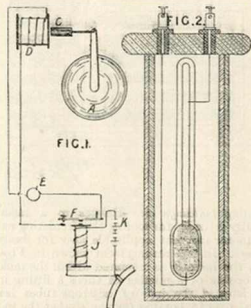

1904]

ABRIDGMENT CLASS HEATING.

17,304. Firth, A. Aug. 8.

Heating water.—A boiler, heated by gas or other fuel, for use in connection with hot-water circulation and domestic purposes, contains a pipe or flue, coiled helically or otherwise, through which the hot gases pass. The coiled pipe D is attached to the apex of the conical lower plate B of the boiler A. The gas burners C are arranged in the recess formed in the flange A'.

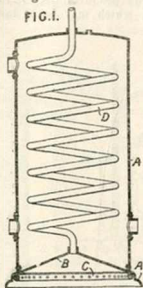

17,304A. Firth, A. Aug. 8.

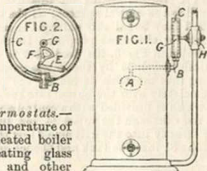

Thermostats.—The temperature of a gas-heated boiler for heating glass houses and other buildings, and for domestic purposes, is kept constant by automatically controlling the supply of gas by means of a liquid which vaporizes at the desired temperature. A bulb A containing this liquid is, in one arrangement, placed in the boiler and connected by the pipe B with a Bourdon tube C. The motion of this tube, when actuated by the vapour pressure, is conveyed to the gas-supply tap H of the burner by the link E, rack F, and pinion G. In heating greenhouses &c., the bulb A is placed outside the boiler, to take the temperature of the room.

17,372. Jones, H. Sefton-, [Hering, M.]. Aug. 9.

Thermostats.—Relates to apparatus for maintaining a constant temperature in an enclosed space, such as an incubator. The apparatus is controlled by a thermometer placed in the enclosed space. The burner 6, which heats the incubator or other apparatus, is supplied with gas through the pipes 2, 3, 3'. In the pipes 3, 3' are valves 10, 11 connected respectively, by means of the rods shown, to the armatures of the electromagnets 18, 19. One of the terminals of the electromagnets, which are connected together, communicates with the battery 21, and the other two are connected to platinum wires placed in the thermometer at the points

indicating the highest and lowest temperatures allowable. A Six's thermometer is shown in the Figure, but any other thermometer may be used. The pipe 2 serves only to supply a small ignition

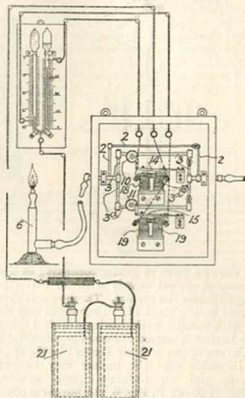

flame. When the temperature falls, a current passes round the electromagnet 19, and the armature 15 opens the valve 11. In a similar manner, when the temperature rises, the armature 14 closes the valve 10.

17,373. McCartney, J. Aug. 9.

Heating water.—Auxiliary conical vessels are used in connection with water heating apparatus, and are placed either directly over the heating means or so as to utilize the waste gases. In the form shown in Fig. 1, water enters by a pipe 6 into an annular tank, and passes from the bottom of this, through a tube 7, into a conical vessel 8 heated by a burner 9 surrounding the tube. Thence it rises by a pipe in the central flue 4, and passes out by the pipe 11 into the service system; the pipe 11 may also communicate directly with the top of the tank. The construction

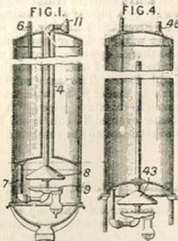

shown in Fig. 4 is similar, but in this case the exit pipe 46 is at the top of the tank, and the pipe leading from the conical vessel 43 heated

by the burner, passes into the tank. The combustion products pass round the outside of the tank, which may be enclosed in a loose casing.

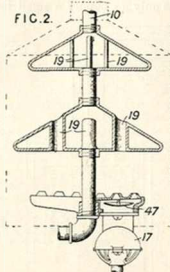
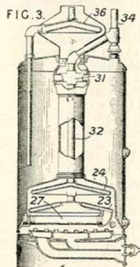
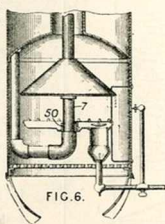

Fig. 2 shows a form of heater consisting of a series of connected conical vessels with an exit pipe 10 leading to the service system. These vessels have flat bases and hollow stays 19. The vessels may also be cones with parallel walls, having a central aperture. In the burner, a convex annular spreader 47 directs the mixture of gas and air formed in the chamber 17. In order that the burner may be readily removed, and an ordinary grate substituted therefor, as shown in Fig. 6, the burner is provided with a central aperture larger than the tube 7, and a radial passage running therefrom to the periphery just wide enough to allow the passage of the tube. A sleeve 50 rests on a coupling on the tube, and



has an annular flange, so that the burner may be slipped into a position resting on this flange, the sleeve 50 filling the central aperture on the burner. Or the tube 7 may be suitably enlarged or cut away at some part, for the same purpose. In the construction shown in Fig. 3, the feedwater is heated in the conical vessel 36 by the waste gases, and, after passing into the tank, is led by the pipe 27 placed immediately over the burner into the conical vessel 23, which is provided with a central aperture. Thence it rises through the vessel 24 and tube 32, and either directly into the exit pipe 34 or through the cross-tube 31 into the tank and thence into the exit pipe.

17,758. Coulston, J. A., and Donald, G.
Aug. 16.

Heating water.—Water is produced into a reservoir *a* by a pipe *a*³ terminating behind a partition *a*¹. From the reservoir, the water flows down an outer water jacket *a*² into coils *c* above the burners, and thence upwards through a multitubular boiler *d*, the tubes of which slope inwards from the top and bottom. The draw-off cock *g* communicates with a header *f*, to which an expansion pipe *f*¹ and an overflow pipe *f*² are also fitted. Any steam evolved is condensed by the condensers *h* and returned to the reservoir.

17,801. Nesbit, D. M. Aug. 16.

Steam traps.—The trap is introduced as a self-contained piece of apparatus into a steam-pipe, radiator, or other chamber to be drained, whereby no considerable projection appears. Reference is made to the thermostatic devices described in Specifications Nos. 12,850 and 12,852, A.D. 1904. Fig. 1 shows the trap in its simple form, Fig. 2 the arrangement adopted for obtaining a multiplying movement, and Fig. 3 the application of the

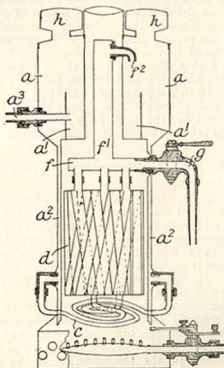

trap as applied to a steam or return main. The trap is connected to the chamber or main by the inlet *b*, the outlet for water being shown at *m*. The iron rod *e* to which the valve *f* is secured is

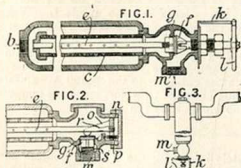

carried by the perforated copper tube *c*. The position of the valve *f* in regard to its seating *g* is adjusted by the external hand-wheel *l*, to which the pointer *k* may be attached. The connection between the hand-wheel spindle and the valve is such as to permit of an opening of the valve without a movement of the spindle. To obtain a multiplying movement, the rod *e* acts upon the disc *n*, Fig. 2, which is pivotally displaced, the rod being reduced at the neck *r* to assist in this action. Upon the disc *n*, arms *o* are formed so as to press upon the valve *f*, which may be raised by the spring *s*. By adjusting the screwed pivot *p*, the arms relatively to the valve may be varied. The arrangement of the valve within the valve-body and the method of carrying the expanding and contracting rod is not limited to that shown, it being capable of variation to suit various sizes or types of valves. The steam may be allowed constantly to pass through the trap, as shown in Fig. 3. Sometimes the outer casing is dispensed with, and the steam and water caused to act directly upon the projecting rod, the end of which is suitably carried. To prevent injury from excessive expansion, a yielding spring or other elastic device may be placed between the thrust-rod and the valve connection.

17,935. **McGregor, D.** Aug. 18.

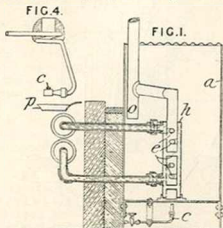

Heating water; heating buildings &c.—For heating water for circulation through a greenhouse, a

vertical annular boiler *b*, fitted with horizontal cross water tubes *e* arranged in spiral ascent, is mounted in a separate chamber *a* outside the greenhouse, and is heated by gas or vapour burners *c*. Two burners may be employed, of which one only is necessary when the boiler is once heated. A down-draught escape aperture *o* prevents lighting-back or extinction of the burners. When the burners are adapted for burning oil, the fuel flows from an elevated tank through a filter and a siphon trap to the burner, which is shown in Fig. 4. Ignition is effected by burning a small quantity of methylated spirit beneath the burner in the vessel *p*.

18,093. **Heath, C., and Robey, W.** Aug. 20.

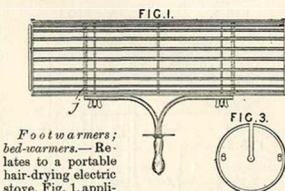

Foot warmers; bed-warmers.—Relates to a portable hair-drying electric stove, Fig. 1, applicable also as a

foot, bed, food, and room warmer. The lamp is held between two springs *j* and is protected by a cylinder made of rods or perforated metal and closed at one end, with a hole for inserting the lamp at the other. This hole is closed by a cover, Fig. 3. The frame is provided with a detachable foot or handle.

18,104. **Gold, E. H.** Aug. 24, A.D. 1903, [date applied for under Patents Act, A.D. 1901].

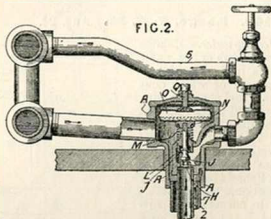

Heating by steam circulation; heating buildings; thermostats.—In apparatus for heating by steam circulation, especially applicable to railway and tramway vehicles, the supply of high-pressure steam from a train-pipe to radiators located in each car

and open to the atmosphere is controlled by a thermostatic arrangement which is actuated by the changes in temperature of the fluid leaving the radiators. A casing A is connected to the outflow pipe from the radiators and to a drip pipe 7 open to the atmosphere. Within this casing is arranged a compartment having one port H open to the steam-inlet pipe 2 leading from the train-pipe, and another port open to the valve-controlled inflow pipe 5 leading to the radiators. The port H is fitted with a nipple forming a seat for the valve J. The stem of the valve J, which is provided with a collar j and surrounded by a packing-ring, passes up through a nipple L in the upper part of the

compartment to the underside of an expansion chamber O. The chamber O is held on its upper side by an adjustable screw-threaded spindle Q and is provided on the underside with a collar N into which the stem of the valve J passes. A spring M tending to force the valve J off its seat abuts against the collar N and the nipple L. When the valve in the inflow pipe 5 is closed, the steam pressure in the pipe 2 forces the collar j and surrounding packing to make a tight joint, no steam thus passing through the radiators. As steam flows through the radiators to the casing A, it heats the expansion chamber O, which, when the temperature rises too high, closes the valve J.

18,125. Wyman, C. F. Aug. 22.

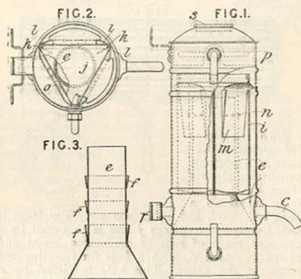

Heating water.—A geyser consists of an outer casing and an inner cylinder *e* on which is supported a triangular hood *i*. The cylinder *e*, shown

separately in Fig. 3, has a lower conical portion, and is fitted with tiers of collars which form annular chambers *f*. The hood *i*, which rests on the conical part of the inner cylinder, is provided on each side with pockets *m*. The upper portion of the hood is closed by a plate *j* which forms with the sides of the hood a shallow tray. Water is distributed in the apparatus by a triangular pipe *p* so that it falls into the tray and into the pockets *m*. Some of the water caught by the tray passes through perforations *k* in the corners of the tray, and runs down strips *l* located below the perforations *k*. The rest of the water overflows through slits in the corners of the tray and runs down the outside of the hood into perforated channels *o* formed at the bottom of the hood. The water from the pockets *m* passes through perforations *n* on to the inner cylinder, filling and overflowing successively the pockets *f*. The heated water is drawn off through an outlet pipe *c*, which is interchangeable with one of the lugs *r* adapted to fix the apparatus to a wall. The heated gases from a gas or oil stove, located below the conical portion of the inner cylinder, pass upwards through the inner cylinder, downwards between the cylinder and the hood, and finally upwards between the hood and the outer casing to the outlet *s*.

18,149. Lange, J. J. M. Aug. 22.

Heating water.—Relates to cast steam or hot-water boilers made up of sections each of which contains a fuel chamber with doors and ascending and descending flues. Figs. 6 and 7 show in sectional elevation two rectangular forms of boiler, and Fig. 8 shows in plan, partly in section, a boiler suitable for the corner of an apartment. As regards Figs. 6 and 7, the fuel-chamber 6 is shown enclosed by the water spaces 5 projecting from lateral water walls

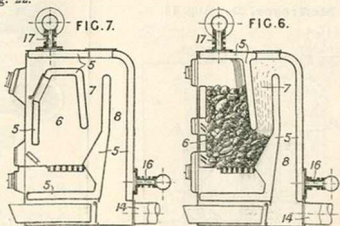

which are common to the next fuel-chamber. The fuel-chambers may open into each other laterally. The spaces 5 also enclose the ascending and descending flues 7, 8, the outlets

being shown at 14. Suitable cleaning-holes, doors, and fuel-entries are provided. The circulating-water connections are shown at 16, 17. When the

FIG. 8.

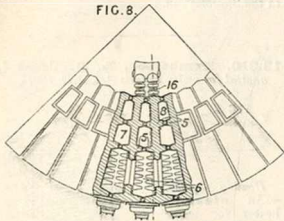

apparatus is for use in the corner of an apartment, the elements composing the boiler are wedge-shaped. They may also be arranged to complete a circle in plan.

18,171. Potterton, T. Aug. 22.

Heating water.—Consists of an arrangement of boiler with a series of hot-water tanks which are provided with cocks for putting one or more out of circulation. Fig. 1 shows the arrangement as applied to a gas stove, and Fig. 2 the form of boiler employed. The tanks *c, c', c''*, in connection with each other by the pipes *d*, communicate by branches having cocks *e, e', e''* with the down-pipe *i*. On suitably closing the cocks, the circulation is

confined to the desired extent. The boiler *A* is formed with the pocket or heating-chamber *m* into which a portion of the gases may enter and escape by holes *o*.

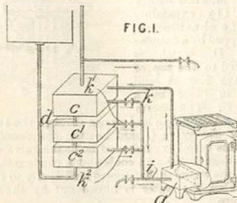

FIG. 2.



18,265. Sullivan, A. W., and Renshaw, W. Aug. 23. *Drawings to Specification.*

Non-conducting coverings and compositions.—Strips of burlap coated with asbestos or felt &c. are placed under the lining of the body of a railway car to diminish the heat transmitted from the exterior.

18,456. Shiels, A. Aug. 25.

Thermostats.—To maintain the air supply to a carburetter at a constant temperature, the pipe contains a regulator *G* comprising a chamber or capsule *G'* containing a volatile liquid supported by the bridge *g*, the underside of the capsule bearing against the end of the pivoted lever *G''*, the other end of which presses the spring flap *G''*. If the temperature of the air supply is too high, the capsule expands and causes the lever to open the flap and admit cold air.

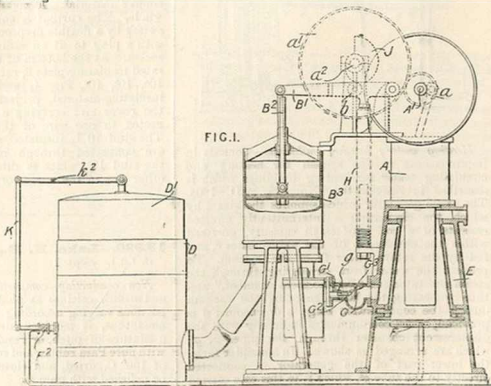

18,768. **Bosshardt, T.** Aug. 30.

Steam traps.—A flexible and expansible vessel *M*, filled with a readily-expanding liquid, such as benzene, is gripped by a tubular piece *D*, which is screwed to the top of a valve box *A* and held in place by a ring *E*. The steam enters at the side *a* and passes through the tube *B*, lifting the valve *C* and heating the vessel *M* so that this vessel expands and holds the valve down. The steam in the trap cools and is condensed, and, when the vessel *M* has cooled sufficiently to release the valve, the water is blown out by the steam pressure.

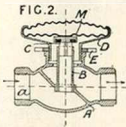

18,903. **Beanes, W. H., and Walton, H.** Sept. 1.

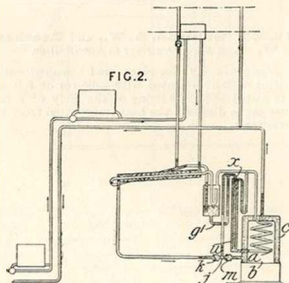

Heating water; heating buildings.—Consists in improvements in the system for heating and circulating water for heating buildings which is described in Specification No. 625, A.D. 1904. The steam generator which supplies the steam by which the circulation is intermittently effected consists of a coil *a* of small capacity, enclosed within the chamber *b* of the water-heater *c*, and fed by the return water from the system. To prevent the water from circulating through the steam generator and "displacement chamber," and thus by heating the latter reducing the vacuum during the condensation stage, a downcomer *u* is provided, which communicates indirectly with the displacement chamber through the pipes *x*, *g'*, which are arranged as shown. In a simpler form, the lower part of the generator is connected directly to the tube *g'*, which is in this case carried

straight down to the point *j* between check valves *k*, *m*. Slight modifications in the manner of connection &c. are also described and illustrated in the Specification.

18,910. **Pemberton, L. B.** Jan. 4, [date applied for under Patents Act, A.D. 1901].

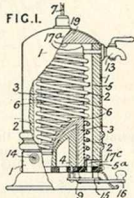
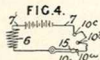

Heating liquids.—An electric heater for water and other liquids contains a heating-coil surrounded by a concentric coil of pipe, through which water is passed and a non-conducting covering. The coils are preferably cylindrical. The electric coil 6 is wound in deep grooves in a cylinder 3 of earthenware, porcelain, or other non-conducting substance, having air vents 17^a and is made of iron, german silver, "Climax" or other alloy. The water coil 2 is of seamless copper, and is provided with a tap 13 and connected to the water supply at 14. Within the cylinder 3 is a cylinder 4 of magnesia, asbestos, or other non-conducting substance. The apparatus has also a surrounding cylinder 5, a convex cover 19, and a washer 5^a, having air holes 17^b, all of similar material. A metal case 1 surrounds the whole. The current is conveyed to the coil and switch by a flexible fireproof conductor 7, provided with a plug to fit an ordinary incandescent-lamp socket. At the bottom of the cylinders is a perforated insulating-plate 9, carrying contact-studs 10, 10^a, 10^b, 10^c. Fig. 4, and a switch arm 16 of insulating-material, projecting through a slot in the cover and carrying a contact-plate 15, connected to one wire of the flexible conductor 7. The stud 10 is insulated, and the studs 10^a, 10^b are connected through regulating-resistances to the stud 10^c, which is directly connected to the other wire of the conductor.

18,920. **Lake, H. H.,** [Soc. Anon. Matthey & Co.] Sept. 1

Non-conducting compositions.—A mixture of amianthus, calcium sulphate, and water, in proportions varying according to the fineness of the amianthus, is moulded, dried, impregnated with a mixture of pitch, or residue of tar distillation, with pure Para rubber and sulphur at a temperature of 150° C, dried, and cleaned. The product can be polished with gum lac.

18,955. Hutchinson, T. R., and Lawson, A. J. Sept. 2.

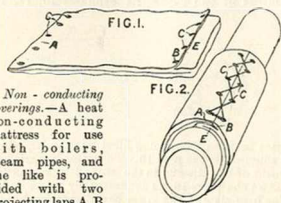

Non-conducting coverings.—A heat non-conducting mattress for use with boilers, steam pipes, and the like is provided with two projecting laps A, B so arranged that, when strained into position around a pipe or other object, a part E of the mattress covers the joint or meeting edges of the laps, thus making the mattress heat-tight around its whole circumference. A series of eyelets C or equivalent devices may be arranged in each lap, and secured together with cords or the like, so that the mattress is easily removable.

18,989. Müller. R. Sept. 2.

Non-conducting compositions.—Asbestos, with or without a filler such as quartz, kaolin, and the like, is mixed with a small quantity of pitch dissolved in a volatile organic solvent, such as benzol. The last portion of the solvent may be expelled *in vacuo*. The material thus made resists heat, acid, alkalis, fire, water, and electricity, and may be moulded, polished, and enamelled.

19,092. Duckworth, C. Sept. 5.

Heating-apparatus; heating liquids.—In a modified form of the mixing machine described in Specification No. 16,230, A.D.1901, [Abridgment Class Mixing &c.], a rotating tube *j*, fitted in the portion *a* supported by the hollow trunnions *d, d'*, is heated by a bunsen burner with the flame always vertical, or by steam. A valve *k* is opened and closed by a cam *l* and lever *m* during rotation.

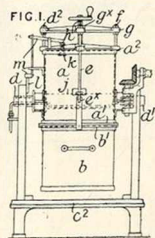

19,235. Coppridge, J. A., and Williamson, P. Sept. 6.

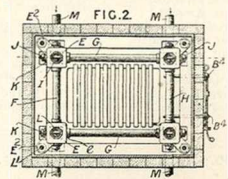
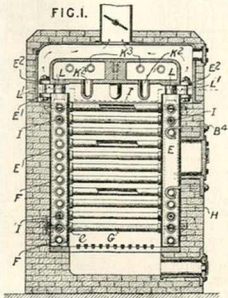

Heating water.—A boiler for heating water is shown in vertical longitudinal section in Fig. 1, and in plan in Fig. 2. Stand-pipes E connected by horizontal pipes F, G, H form the firebox of the furnace. The pipes E are provided with internally-tapering bosses into which the ends of the horizontal connecting-pipes fit; the whole apparatus is held together by tie-rods I in the connecting-pipes, passing through the stand-pipes and tightened by means of nuts J. The tops of the stand-pipes are provided with tapering recesses in which short connecting-tubes L fit; the other ends of the tubes L fit into corresponding recesses in an upper "dome" K which is held tightly down on the stand-pipes by means of bolts L¹ passing through lugs E¹, E². Tubes K² hang from the dome or crown K, and outlets K³ lead the heated water direct to radiators. Tubes M, Fig. 2, return cooled water from the radiators to the lower part of the apparatus. The frame of the firebox door is secured in place by hooked rods, the hooks of which pass around the horizontal pipes H, and which are fastened by bolts B⁴.

19,595. **Boult, A. J.**, [Molas, E.]. Sept. 10.

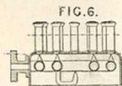

Heating liquids.—To prevent a backrush of the products of combustion in connection with boilers for domestic purposes, for sterilizing liquids, and for baths, air for combustion is obtained from the atmosphere by means of a pipe concentric with the chimney, thus producing an equalization of pressure in the combustion chamber. A method of forming corrugations upon the plates of the boiler and an arrangement of gas burners are also described. As shown in Fig. 1, the whole length of the flue 37 is connected by semicircular

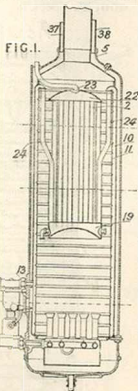

stays, as illustrated in plan in Fig. 11, to the concentric pipe 38 which carries the air to the burners or fire placed at the base of the boiler. The latter consists of two concentric cylinders 10, 11, the

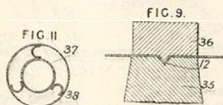

space between them being filled with water, which is supplied by the pipe 13. The water is carried by means of the pipes 24 to the heater 2, which consists of two chambers 19, 22 connected by water tubes. The base-plate of the lower chamber is concave to cause the condensation water from the burners to fall clear of them. The upper chamber is provided with the pipe 23 to convey the steam or hot water away. The air descends to the burners through the space between the cylinder 10 and the casing 5. The burners shown in Fig. 6 are arranged in concentric rings, the pipe supplying the central burner being bent as shown to collect and remove by vaporization any water contained in the gas pipes. The burners are of the bunsen type, surmounted by wire gauze. The sides of the cylinder 11 are strengthened by being corrugated by the method shown in Fig. 9, in which the punch 36 strikes the plate arranged on the die 35, provided with a suitably-shaped groove 12. Various methods of arranging the flue and surrounding pipe are illustrated in the Specification.

20,450. **Robson, R., and Dufton, J. W.** Sept. 22.

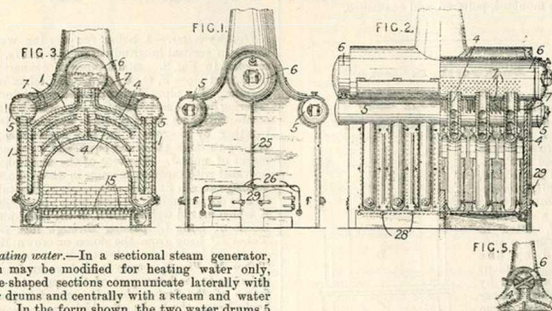

Heating water.—In a sectional steam generator, which may be modified for heating water only, saddle-shaped sections communicate laterally with water drums and centrally with a steam and water drum. In the form shown, the two water drums 5 communicate with the sections 1, the latter being in connection with the drum 6. The central portion is divided into arched waterways 4. The pipes 7 are dispensed with when not employed for steam

generation, and smoke tubes are added. A forced draught is obtainable by means of the pipes 25, 26 and the nozzles 28.

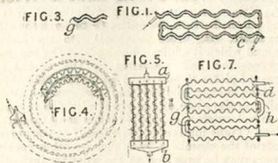
20,557. **Mewes, R.** Sept. 23.

Heating gases and liquids.—In radiators, boilers, or the like, made of corrugated sheet metal, the sheets forming the single elements are either folded along their middle or two sheets of the same size and shape are placed one above the other; the plates are then secured together at their edges so that the heating-gases pass through the channels formed by the superposed corrugations, while the medium to be heated travels transversely over the corrugations. Fig. 1 shows a horizontally-placed automobile cooler formed of two superposed sheets between the borders of which a strip or band *c* is placed and riveted to the two plates. Fig. 3 shows a similar element formed of a single sheet folded at *g*. In another modification, Fig. 4, a refrigerator or radiator of corrugated sheet metal is formed by winding an element into a scroll. The different spiral windings may communicate with each other through tubes (not shown). Fig. 5 shows a radiator in which the elements are made of corrugated sheets with flat borders bent to a rectangular shape and joined together at the borders. The passages formed between the sheets communicate with tanks *a, b*. In another apparatus, Fig. 7, several elements formed of corrugated plates folded at *g* and secured by rivets *d* communicate with each other by means of bent tubes *h*. The different elements may be in direct communication with the tanks through circular holes or slits.

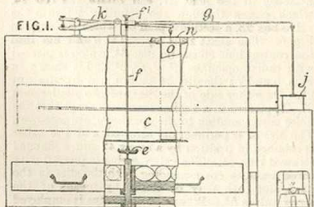
20,678. **Mallon, R.** Sept. 26.

Thermostats.—In an incubator, lever mechanism is combined with a thermostat so as to control the

dampers of the ventilating-flue and lamp chimney simultaneously. A rod *f* from the thermostatic capsule *e* passes through the top of the incubator and bears against an adjustable screw *f*¹ in a pivoted lever *g*, one end of which carries the chimney damper *j*, while the other is hinged to one end of a second pivoted lever *k*, which carries the ventilating-damper *n*. When the temperature rises above the normal, the dampers are lifted and the hot air within the incubator escapes through the flue *o*, and that from the lamp passes directly into the atmosphere instead of through the flue *c*. The invention may be applied to incubators in which hot-water tanks are used.

20,864. **Barralet, T. E.** Sept. 28.

Heating water.—The water flowing into a geyser first falls upon a perforated convex plate *a*, Figs. 1 and 4, provided with a lip *b* and tongue *c* at each aperture, to divide the water into thin streams. The plate *a* has radial cuts at its periphery, and the alternate strips thus formed are bent down to permit water to escape at the circumference, to keep the walls of the vessel cool. A plate *e* is interposed to prevent any water from falling on the burners. The heated liquid is finally drawn off from the annular trough *h*.

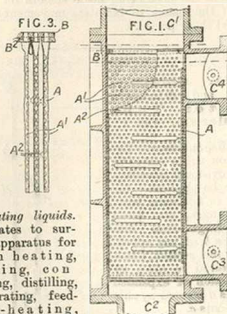
20,938. **Shiels, A.** Sept. 29.

Heating liquids.—Relates to surface apparatus for use in heating, cooling, condensing, distilling, evaporating, feed-water-heating, steam generating

and superheating, and oil purification. A metal sheet, suitably embossed or provided with corrugations, nodules, and the like is folded upon itself several times, or separate sheets may be employed, to form an alternating series of chambers for the passage of the hot and cold liquids. As shown in sectional elevation in Fig. 1, the sheet A is folded or separate sheets are employed and arranged in a casing with the folds vertical. Preferably, each wall of the chambers thus formed is provided with nodules A^1 on one side and ridges A^2 on the other, as shown in Fig. 3, which is a part section at right-angles to Fig. 1. The ridges A^2 are staggered, as seen in Fig. 1, and water or other cooling-liquid which enters the chambers at C^2 is

thus caused to take a zig-zag course to the outlet C^1 . Steam or other heating-medium enters at C^1 and passes down to the outlet C^2 through the other chambers, viz., those provided with the nodules around which it eddies. The ends of the chambers are secured and protected by the slotted and grooved plates B, and tight joints are effected by pouring rubber solution into the grooves B² and painting the edges of the sheet with the same and then vulcanizing the rubber when the edges are in place. Tight joints are also effected at the vertical ends of the chambers by rubber or other packing. Doors may be provided at the sides for inspecting or removing the sheets. Several of these chambers may be arranged in combination in the same casing.

21,018. Bottomley, J. F., and Paget, A.
Sept. 30.

Non-conducting coverings and compositions.—Relates to methods of attaching metals to objects of fused silica &c., for strengthening the silica, and for providing means for utilizing the thermal insulating properties of silica. The metal in some cases may be cast directly round the outside of the silica. Where portions only of the silica are surrounded by metal, sudden differences of strain may be avoided by slitting and graduating the thickness of the surrounding metal. The metal may be cast on in several layers, or an outer layer of a hard metal may be cast as to leave between it and the silica a space which is subsequently filled with soft metal. The metal may be cast inside a mass of silica, the inner surface of the latter being roughened or shaped so as to retain the metal. In some cases, hollow spaces may be left between parts of the metal and silica, the spaces being formed by a yielding wrapping of asbestos in cord or other form. Where the wrapping is not continuous, the spaces are formed by longitudinal wrappings, the surface of the silica being made smooth on either side of the spaces to facilitate movement of the metal at these points.

21,094. Crowther, D., and Glover's Water Tube Boiler Co. Oct. 1.

Heating buildings.—Return-flow tubes, stated in the Provisional Specification to be applicable for hot-air or hot-water heating systems, are fitted with longitudinal diaphragms b , of any appropriate cross-section, which are secured in place by the friction of expanded tongues d formed by slits or saw-cuts c .

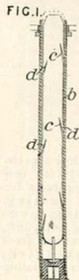

21,106. Bice, W. H., and Bice, A. W.
Oct. 1.

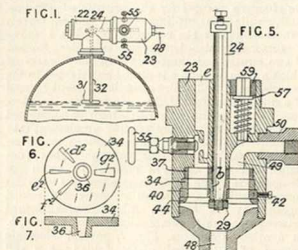

Heating liquids.—A rod, rotated by the rise and fall of a float in a boiler &c., causes the rotation of a disc with radial openings, between two other discs with similar apertures. These, together with screw valves, regulate the supply of steam to a feedwater pump. The inclined rod 32, Fig. 1, attached to the float 31, can rotate the rod 24, which passes through the coupling 22 into the valve-box 23, a sectional plan of which is shown in Fig. 5. The shaft 24 is tapered at b and fits into the central hole 36 in the disc 34, which is pierced with radial openings a^1 , e^1 , f^1 , g^1 , and is shown in Figs. 6 and 7; the disc 34 is retained by the nut 29. On either side of the disc are two similar ones 37, 40, pierced in a similar manner except that the holes corresponding to the opening g^1 are narrower. The disc 37 is peripherally screwed, and the other is retained in position by a screw 42 and a flanged screwed ring 44. The valve casing is pierced with three passages corresponding with the slits in the discs, and each may be closed by means of the screw valves 55. When the apparatus is employed to control the level of water, oil, &c. in tanks, the passage 49 in line with the opening g^2 may be connected by means of a bye-pass pipe at 50 with the discharge pipe of a pump. A spring-controlled

valve 57, for use in connection with a boiler, is opened when the steam pressure is just insufficient to operate the safety-valve, the force of the spring being adjustable by means of the hollow screwed ring 59. The apparatus works as follows:—The discs are adjusted so that when the water is low the openings are in line. Steam then passes from the boiler through the pipe 48 to a pump, which pumps in water through a pipe (not shown). As the float

rises, the amount of steam passing to the pump is diminished by the rotation of the disc 34, until the required level is attained, when the steam is cut off. If the steam pressure is great, the valve 57 opens and steam can proceed to the pipe 48 by the passage 49 and opening *g*'. It is stated that the float may be surrounded by a cage to prevent undue motion, for example, in portable and marine boilers.

21,186. Stoneham, W. G. Oct. 3. *Drawings to Specification.*

Heating buildings &c.—A system of heating water for warming buildings &c. consists of a circulatory arrangement of pipes, which pass through

the gas or oil stoves, fireplaces, and flues, and are connected up in the usual manner with a supply tank. The pipes pass from floor to floor and are provided with cocks at convenient places. The flues of stoves may be water-jacketed or bent over into vessels of water connected with the system.

21,320. Fullagar, H. F. Oct. 4.

Heating air and gases.—A turbine is worked by products of combustion at a pressure of 28–45 lb. and at a temperature of 1300°–1700° C.; the air or air and fuel are heated in a regenerator by the exhaust, and some of the cooled exhaust may be mixed with the air as described in Specification No. 6317, A.D. 1904, [*Abridgment Class Air and gas engines*]. Fig. 5 shows a turbine *e* driving a dynamo 2 and a pump *r* of the turbine type which forces air through the regenerator 11 to the combustion chamber *a*. The regenerator may be composed of straight tubes with expansion joints or right-angled tubes, or it may be constructed of sinuous plates 10, 10^a,

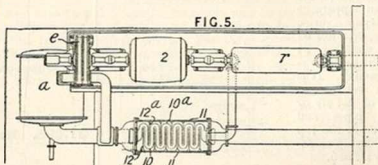

corrugated if desired, between which the air passes; baffles 12 direct the exhaust gases through the casing 11. The tubes and plates are made of steel, and their hotter ends are made of, or coated with, nickel.

21,436. Northcott, W. H. Oct. 6.

Steam traps.—

Relates to means for regulating the drainage from the separators of wet air-compressors. In the arrangement shown in Fig. 5, the drain pipe *E* is controlled by a valve *D* connected to a piston *A* working in an adjacent cylinder and held up by a spring. Normally, the valve is completely immersed in the separated liquid and is held open, liquid only being discharged through adjustable valves *F*, *G*; if the drainage is too rapid, however, compressed air escaping with the liquid pushes down the piston *A* and closes the valve. In another arrangement, the separator is provided with a float

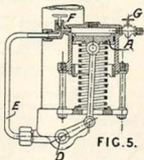

having a stem with a conical end, which is adapted to make and break the circuit of an electromagnet operating a valve in the drain pipe.

21,451. Barratt, S. H. H., and United Asbestos Co. Oct. 6.

Non-conducting coverings.—The flanged joints of steam pipes &c. are enclosed by a metal casing *a*, made in halves and fitted with a removable lining *b* of rope asbestos or the like. The lengths of asbestos are bound together with wires *c* and are secured in place by wire clips *d*. Varnish and other waterproofing-material may be applied to the inner side of the lining; or an inner metal casing may be fitted. A drip-pipe *e* is provided. The applications to the flanged joints of large vessels and to valves and steam separators are mentioned.

(For Figures see next page.)

21,451.

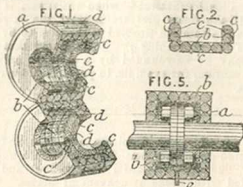

built up in sections bolted together, and is supported on feet c, d. More than one ring may be

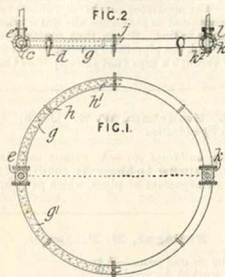

21,469. Walker, K. R. Oct. 6.

Heating air.—Air for an apparatus for drying yarns, fabrics, &c. is heated in a chamber 24 adjacent to the drying-chamber. It is drawn between a series of hot-air or steam pipes and supplied to the top of the drying-chamber by a fan 5.

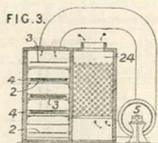

employed. For small rings, the inlet and outlet connections are made in one casting.

21,596. Bedford, J. E., Bedford, C. S., and Crowther, E. Oct. 8. *Drawings to Specification.*

Heating liquids.—In soap manufacture, the materials are combined and the soap concentrated and dried *in vacuo* in the same apparatus, which consists of a steam-jacketed cylinder, provided with stirrers which spray the liquid.

21,721. Chubb, H. R. Oct. 10.

Heating liquids; boiling-pans.—Steam-heated coils, grids, and the like are fitted internally with perforated distributing-pipes, which prevent direct contact of the entering steam with the condensed steam. Figs. 1 and 2 show the application to a ring suitable for use in brewers' coppers. The distributing-pipes g, g' , extending laterally on each side of the inlet e , are perforated at the top and are provided at the free ends with restricted outlets j ; they are held central by flanges h, h' . The outlet k for the condensed steam is opposite the steam inlet e , and is provided with a small pocket k' into which the outlet pipe l dips. Drain openings are provided on the undersides of the pipes g, g' . The ring is

21,898. Donnelly, J. A. Oct. 11.

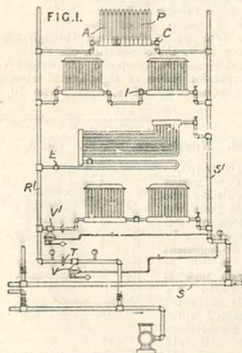

Heating buildings &c.; steam traps.—The general arrangement of a low-pressure steam heating-system, in which the exhaust from a steam engine may be employed, is shown in Fig. 1; Fig. 2 shows a valve for regulating the pressure difference between the supply and return mains, and Fig. 3 a

valve for restricting the flow from the primary radiators P. The steam main S supplies steam to the supply mains S' of each heating section, which communicate with the radiators through

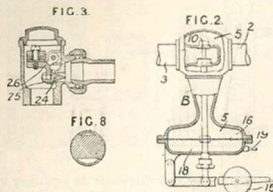

stop valves C. The radiators are constructed with a primary part P, and an auxiliary part A to condense any steam passing the restricting-device I, which may consist in the valve shown in Fig. 3. Check valves E or reducing-valves V¹ may be inserted between the auxiliary radiators

and the return mains R¹. Each return main is fitted with a regulating-valve V protected by a strainer T. This regulating-valve V, V¹ consists of a casing B, Fig. 2 forming two chambers 5, 18 separated by a flexible partition 16, the motion of which, together with the action of an adjustable weight 15, controls a double-beat valve 10, the seatings of which are formed in a U-shaped partition in the upper part of the chamber 5. The lower chamber 18 communicates with the high-pressure main by means of a pipe 19. An increase of pressure in the supply main, or a decrease in pressure in the return main, thus diminishes the area through which the returning fluid can pass from the inlet 2 to the outlet 3 to the air pump, and vice versa. The restricting-device I shown in Fig. 3 consists of a conical valve piece 24 formed with a suitable impact surface 25 and attached to one limb of a loaded lever 26. During normal working, the valve remains slightly open, but, should the water of condensation collect in sufficient quantity, a jet of water is produced which strikes the surface 25 and throws the valve wide open. Its action may be supplemented by fitting a perforated disc, Fig. 8, in the outlet from the radiators. The valve shown in Fig. 2 serves as a steam trap when closed against the escape of air, since the static head of water acts upon the diaphragm to control the valve.

21,962. Benson & Co., W. A. S., and Andrews, F. A. Oct. 12.

Heating-apparatus; footwarmers.—An apparatus applicable as a food, plate, and dish warmer, or as a footwarmer &c., comprises an outer metal vessel A within which is supported a perforated metal tray B fitted with a lid D on which are placed the materials to be warmed. The outer vessel A has an aperture *a* in its lower part, above which is arranged a baffle-plate *a*¹. The perforated tray B contains a heating-device consisting of incandescent electric lamps, bunsen gas burners, or spirit lamps, &c. Air, entering through the aperture *a*,

circulates through the perforated tray and escapes through a space *d* between the lid D and vessel A.

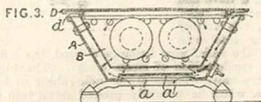

The inside of the tray and the outside of the lid are polished, and the inside of the lid is blackened.

21,969. Mortensen, F. Oct. 12.

Heating liquids.—A heating coil or series of tubes is suspended in a tank or vat so as to be moved throughout the liquid. The coil is suspended from two shafts C which pass through bearings B and are supported by rollers E. The rollers E run on pieces of angle-iron attached to the sides of the tank. The carriage from which the coil is suspended is connected by a lever H to a tap fitted on one link in each of the chains F. These chains pass over chain-wheels G driven from the shaft K. The coil is connected to the supply of hot water or steam by flexible hose L, L¹.

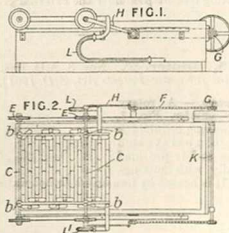

22,074. Davidson, S. C. Oct. 13.

Heating air.—Smoke impregnated fog is removed from air for ventilation purposes by first heating the air, to render it substantially dry, and then filtering it. A form of apparatus adapted to be set up in two rooms A, B separated by a partition comprises essentially a preliminary heater D, a filter E of the type described in Specification No. 8687, A.D. 1902, [Abridgment Class Air and gases, Compressing &c.], consisting of a wetted foraminous screen mounted on a rotating drum,

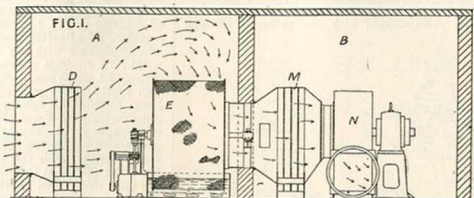

a secondary heater or refrigerator M, according to requirements, and an exhaust fan N. The Provisional Specification states that batteries of steam pipes form a suitable heating-apparatus.

22,121. Davey, J. Oct. 14.

Heating water.—The cylinder of a domestic or like hot-water supply apparatus is fitted with an excess-pressure valve and a vacuum relief valve, the former coming into use when the relief pipe becomes blocked, the latter when condensation of steam occurs. The high-pressure valve consists of an india-rubber or like ball *i*, which is normally pressed down into its seating by a weight *k* on the lever *k'*. The escaping water and steam are conducted outside the building by the sloping pipe *o*, thus preventing lodgment of water and stoppage by freezing. A valve within the tube *g*, opening upwards, allows air to enter when the pressure within the apparatus falls, hence preventing its collapse under the external pressure.

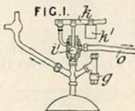

22,245. Didier, T. Nov. 3, A.D. 1903, [date applied for under Patents Act, A.D. 1901].

Digesters.—A rotary mixing-cylinder, Fig. 1, for dissolving celluloid is made to resist high pressure and is provided internally with mixing-rods. It is heated by immersion in hot water.



22,590. Barker, A. H. Oct. 20.

Heating by water circulation.—Water is circulated through the pipes *m* by a pump *d*, and is heated in the expansion chamber *a* by the exhaust steam from the pump, by live steam direct from the boiler *f*, reduced to about atmospheric pressure by a valve *n*, or by steam from both sources simultaneously. The water is delivered from a perforated pipe *e* placed at the top of the expansion chamber, and falls through perforated trays *b*, becoming heated in its passage by the steam which is supplied by the pipe *g*, and escapes at *h*. An overflow pipe *r* communicates with the boiler feed-pipe. An ejector or other direct steam heater *k* may also be employed.

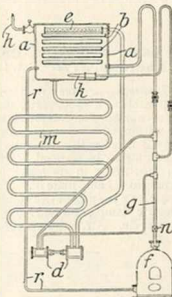

22,741. Bolze, H. A. Oct. 22, A.D. 1903, [date applied for under Patents Act, A.D. 1901].

Heating buildings; heating water.—In a hot-water

heating-system, the water is kept at a constant head, and the circulation is maintained and regulated independently of the level of the source of heat. Above the highest point of the system, shown in its simplest form in Fig. 1, are two open vessels *k*, *i*, which are in communication through the pump *o*. Water passes from the upper vessel *i* to the boiler *a*, and thence to the radiators; it returns to the lower vessel *k*, from which it is pumped to the vessel *i*. A constant

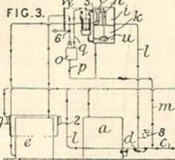
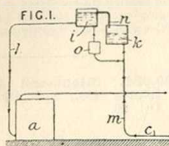

head is maintained by means of an overflow pipe *n*. In the complete arrangement, shown in Fig. 3, the vessels *i*, *k* are formed in one, and the overflow pipe *n* is placed inside. The return pipe *c* leads back to the boiler *a*, and the pipe *l* joins the pipe *c* on that side of the pipe *m* nearer the boiler. A valve *d* is provided in the pipe *c* between the junction of the pipes *l*, *m*. A steam boiler *e* supplies steam for working the pulsometer *o* and for heating the water in the pre-heater *g*. A three-way cock *2* regulates the flow of water through the pre-heater. In the place of the overflow pipe *n*, a pipe *5* may be arranged to discharge into a vessel suspended from a lever *w*, the other arm of which is connected to a valve *6* in the steam pipe of the water lifter. In the bottom of the vessel is an opening, so that, normally, water does not collect in the vessel, but, if too much water is being raised, it will fill the vessel and depress it, thus adjusting the valve *6*. In order to prevent water from rising too high in the vessel *k*, a float *u* is connected, as shown, to a valve in a pipe *t*, through which excess of water in the system may escape. The top of the pipe *t* is at a somewhat lower level than that of the overflow pipe *n*. A pump or the like *8* may be placed at any desired point of the system, instead of, or in combination with, the water lifter *o*, and the arrangement described in connection with the water lifter may be used for regulating the pump *8*. It is stated with reference to the pulsometer *o* that no valves are used in the pipes *p*, *q*, and that the heat given to the system in the pulsometer may alone, in some cases, be sufficient.

22,758. Field, H. Oct. 21.

Steam traps.—The valve of a steam trap is controlled by a trigger or detent mechanism which

causes it to open sharply. Fig. 1 shows in the closed position a trap actuated by the expansion of the inlet tube *c*. The contraction of the tube on cooling raises the rod *h* on the lever *i* until the

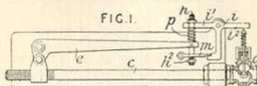

lower stop *h'* lifts the catch *m*. This releases the lever *i*, the arm *i'* of which is caused to press upon the valve spindle by the action of the spring *p*, thus opening the valve *o*. The tube *c* expands upon the entrance of steam, depresses the rod *h* and the arm *i'* of the lever *i*, thus re-setting the trigger *m*.

22,900. Prior, J. D. Oct. 24.

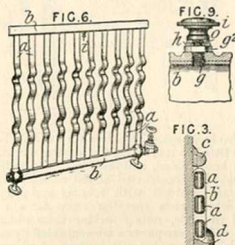

Heating buildings.—Relates to means for heating buildings, but also applicable for other purposes, such as drying and airing clothes. Steam or water is circulated through a number of flat tubes *a*, brazed or permanently connected to end boxes *b*, and waved or corrugated in a part or the whole of their length; or, alternatively, the tubes may be coiled around the end boxes before being secured to them. For heating buildings, the pipes may be fitted round the room in place of the skirting-board, a moulding *c*, Fig. 3, to deflect the heated air, and a guard *d*, to protect the tubes from injury by furniture &c., being provided. To allow for expansion in any cylindrical pipes employed, they may be joined by a piece of flexible tubing. Pipes of the above description may be applied to a radiator, as shown in Fig. 6. A suitable air vent consists of a tube *g*, Fig. 9, formed with a shoulder *g'*, and having a perforation *o* which may be closed by screwing down a cap *i* on to a washer *h*. When fitted in the inverted position, as shown in Fig. 6, the tube *g* is prolonged to the highest part of the radiator or pipe.

22,901. Prior, J. D. Oct. 24.

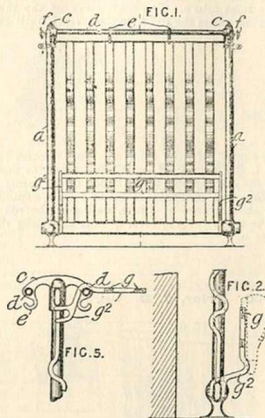

Heating buildings.—Radiators for heating buildings are fitted to serve also for drying and airing clothes, boots, linen, and the like. The radiator, which may be constructed of flat waved tubes, as shown, is provided with tubular end-pieces *a*, within which rods carrying cross-pieces *c* are adapted to slide, nuts *f* locking them where required. The cross-pieces *c* are connected by rails *d* which may be provided with hooks *e*. A removable frame *g* formed with bent end-bars *g*² may be fitted to the bottom of the radiator for drying boots and shoes, which are arranged vertically with the soles towards the radiator; or it may be applied to the top of the radiator as shown in Fig. 5 to serve for drying linen and the like. In place of the tubular end-pieces *a*, simple eye-sockets may be employed.

22,905. Mare, F. de. Oct. 24. Drawings to Specification.

Heating air; heating by electricity.—In an "electrothermic" fan for supplying a current of heated air, a disc provided with a heating-resistance composed of electrically-connected lamellae is rotated within a non-conducting casing of porcelain, glass, glazed earthenware, &c. by an electromotor the speed of which controls a relay for making and breaking the resistance circuit. A fan for supplying heated air to railway and tramway vehicles is driven from a running axle, the current

for heating the resistance being supplied from the power-circuit in the case of an electric car, but otherwise from a directly-coupled alternator.

23,034. Richmond Gas Stove and Meter Co., and Sherburn, W. H. Oct. 26.

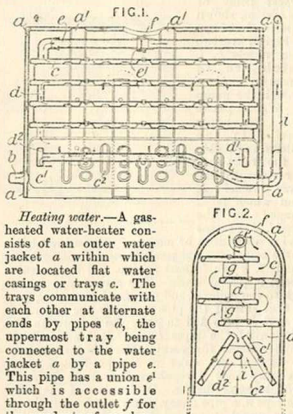

Heating water.—A gas-heated water-heater consists of an outer water jacket *a* within which are located flat water casings or trays *c*. The trays communicate with each other at alternate ends by pipes *d*, the uppermost tray being connected to the water jacket *a* by a pipe *e*. This pipe has a union *e*¹ which is accessible through the outlet *f* for the products of combustion. The trays are also supported by plates *g* at the ends opposite to those at which they communicate. The two lowest trays *c*¹ are inclined to each other and connected by a horizontal conduit *d*¹. From a branch *d*² on the inside of this conduit, a discharge pipe *i* passes between the trays *c*¹ to the exterior of the apparatus. The pipe *i* is carried up above the level of the top of the apparatus so that the latter cannot run dry. The plate forming the underside of each tray is indented as shown at *c*². The upper and lower sides of the trays are riveted together so as to form a longer path for the water, which enters the apparatus by an inlet *b*. The indentations *c*² in the bottom-plates of the trays have parallel sides with round ends, and are formed so as to cause the water to follow a zig-zag course. The casing *a* is similarly provided with indentations *a*¹ which serve as baffles.

23,045. Bollé, C., [Schmidt & Co., C.]. Oct. 26. Drawings to Specification.

Digesters for steaming animal refuse are provided with covers with water or sand seals, and

in the middle with hinge flaps which are operated from the outside, and by closing which a further charge can be introduced into the upper part of

the digester while the refuse is being treated in the lower. The digesters are connected to an apparatus in which the steamed refuse is treated with acids.

23,183. Wells,
W. J. Oct. 27.

Steam traps.—Steam condensed in the jacket of a rotating drying-drum is collected in a pan H and flows through outlet pipes on opposite sides of the pan to a passage in the trunnion B¹, whence it escapes through a hollow collar G¹.

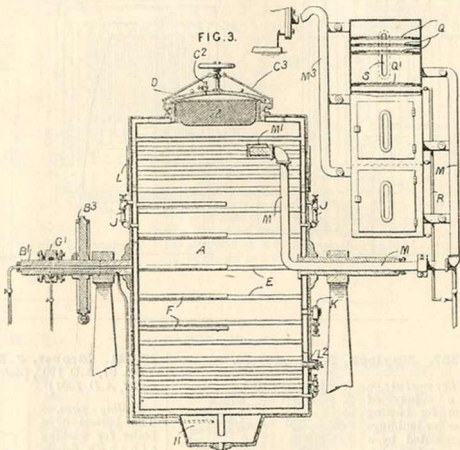

23,310. Westwood, J., Barter, C., and Taylor, T. Oct. 29.

Heating water.—Relates to a sectional hot-water boiler or steam generator, or both combined, for supplying hot water or steam for laundries, drying-rooms, and the like, and for heating, cooking, or general domestic purposes. Each section consists of an upper chamber F divided into upper and lower compartments E, I, with which the inner and outer members G, H of a series of Field tubes respectively communicate. These tubes are of various lengths, as shown, according to their position in the furnace, and are closed by screwed caps. The return water, when the boiler is used as a water-heater, and the water of condensation, when it is employed as a steam generator, is conducted to return headers C situated at each side of the grate A¹ and communicating with the compartments E by means of tubes D. The water then circulates down the inner tubes G and up the outer tubes H, passing thence through connections I to a collector V¹,

from which it again enters the system. A combined boiler of which the steam-generating section A² can be converted at will into an additional water-heating section is shown in Fig. 8. Pipes W, each fitted with a cock X, connect the hot-water drum V² with the steam drum E¹, and the hot-water return headers with the steam-generator return headers. A cock Y on the main steam-exit pipe W¹ is actuated by a system of levers Z so as to be closed when the cocks X are open, and *vice versa*. To reconvert the steam-generating section after use with the water-heating sections, the water must be lowered to the proper working level. The casing L of the boiler is formed of panels, the ends of which are bevelled to fit into grooves K¹ in the headers C, F, the edges being also bevelled to fit tightly together. Channelled firebricks K within the casing form a passage through which heated air passes to a hollow firebridge N perforated at O, and strengthened by stays O¹. The boiler may be heated by producer gas, blast-furnace gas, or other waste heat.

(For Figures see next page.)

23,310.

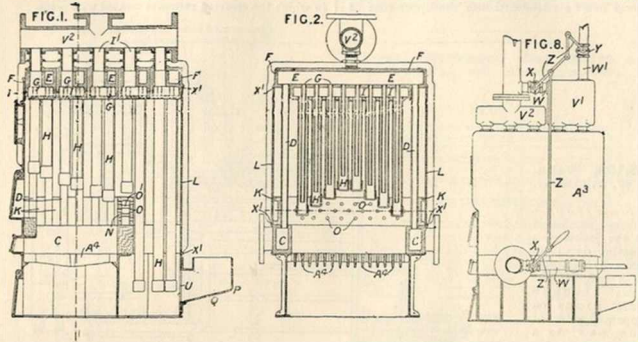

23,337. Haylock, R. H. Oct. 29.

Thermostats.—The supply of steam for heating water for buildings is regulated by a thermostat, consisting of an expansible plug placed in a closed tube immersed in the liquid. The tube 1, secured as shown in the side 2 of the vessel or pipe containing the water, encloses a plug 6, the lower end of which is connected by means of the spring washer 11 and spindle 9 with a valve 7 in the path of the steam. One end of the plug is attached to a sleeve 8, the upper end of which can be adjusted in position, and therefore the lift of the valve 7 regulated, by a screw bolt 10, as shown in Fig. 2. The position of the valve 7 may also be regulated by the nut 9'. In a modification, the lift of the valve is rendered adjustable by means of a lever connection with the spindle 9. The entire construction is such that the working parts may be removed for repairs or renewal without interference with the circulation of the water.

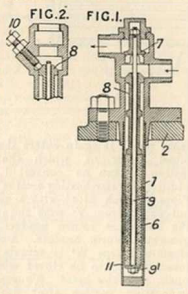

23,441. Brobst, J. L., and Brobst, J. L. Oct. 31, A.D. 1903, [date applied for under Patents Act, A.D. 1901].

Boiling pans.—The bottom of a boiler for washing clothes &c. is divided into separate chambers by means of a false bottom *b* resting on flanges *c* round the sides of the boiler, an inner flange *d*, and partitions *f* connecting the two. The central portion of the false bottom is formed of wire gauze. Tubular flanges *h*, over which pipes *i* are fitted removably with their mouths bending downwards, open into the outer chambers formed by the partitions *f*. Communication between the inner chamber covered by the gauze and the outer chambers takes place through holes in the flange *d*, or beneath this flange. A stream of hot water is directed on to clothes &c. placed on the false bottom from the mouths of the pipes, and water enters through the outer chamber or under the inner flange *d* into the outer chambers to take its place.

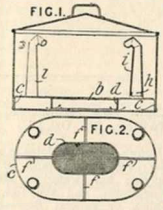

23,525. Dowsing, H. J. Nov. 1.

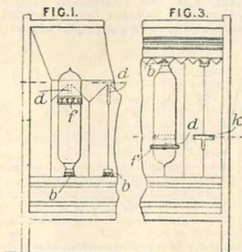

Heating by electricity.—To steady the lamps of electric radiator stoves, bands *f* of metal or other

material surrounding the bodies of the lamps are provided with shaped ends *i, j* which engage slots *d* formed in the reflector or back of the radiator. When the lamp is mounted at its lower end, as

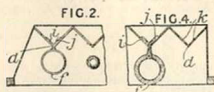

shown in Figs. 1 and 2, the slot *d* extends from the top of the reflector downwards, so that the band may be placed in position after the lamp has been connected to the contact-fitting *b*. Where the lamp is suspended from the contact-fitting, as shown in Figs. 2 and 4, the slot *d* may be formed with a transverse opening *k* large enough to receive the bent ends of the band. The band may consist of a ring of helically-wound wire, the ends of which are attached to a metal strip having bent portions *i, j*, as shown in Fig. 4.

23,624. Schaffstädt, H. Nov. 1.

Heating water.—In water-heating apparatus in which the water is heated by steam pipes traversing it, means are provided to allow for the increase in the volume of the water due to heating. One arm of an inverted U shaped pipe *e* which extends nearly to the top of the hot-water apparatus opens into the bottom and the other leads into the condensed-water pipe *d*, as shown, or into another overflow. The steam heating-coil *b* is connected with the steam-supply pipe *c* and the condensed-water pipe, and the latter may also lead by a pipe to the heating-apparatus, so that this may be discharged or filled from the boiler. When the water is heated, the cold water at the bottom of the apparatus is forced through the U-shaped pipe into the condensed-water pipe. When it cools, any steam in the condensed-water pipe is drawn into and condensed in the heating-apparatus. Air may enter into or escape by an aperture at the bend of the U-shaped pipe. A simple pipe opening at the highest point may replace the pipe *e*.

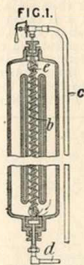

23,705. Kaerle, F. Nov. 2.

Heating buildings &c.—Steam is introduced through the nozzle of an injector into a low-pressure steam heating-apparatus, so as to drive the contained air rapidly out and promote circulation of the steam. The steam enters through the valve *V* and the nozzle *d* screwed to it, and passes thence through the nozzle *d*¹ attached to a union on the nozzle *d*, and a series of nozzles or tubes *d*² connecting the elements of the heater. A brisk circulation is thus produced, and it is stated that the heavier air and condensed water remaining at the bottom are carried off by a pipe. The opening *d*³ of this pipe is in the valve *V*, or in the lowest part of the heater, and communicates with the suction space of the tube or nozzle *d*², any steam being drawn back into the heater thereby. For ease of adjustment,

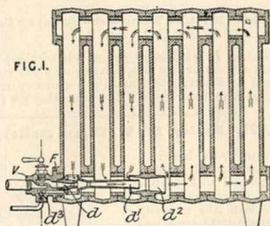

the valve V is provided with a collar F having a thread opposite to that of the aperture provided for the valve in the heater.

23,772. Pieron, H. Nov. 3.

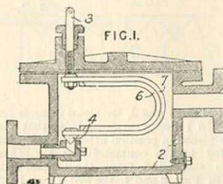

Steam traps.—The valve is actuated by means of a horse-shoe lever formed of two metal strips 6, 7 of different degrees of expansibility and adjustably attached to the casing by a screw 3. Admission of steam to the chamber causes the lever to open out, thus closing the valve 4. The water of condensation subsequently causes the contraction of the composite lever and opening of the valve.

23,816. British Thomson-Houston Co.,
[General Electric Co.]. Nov. 3.

Heating by electricity.—In an electrically-propelled vehicle or the like, heating-coils are connected to the train-wire until the motor current reaches a predetermined value, when they are cut

out by an electromagnetic switch. The system of motor control is described in Specification No. 13,721, A.D. 1900, [Abridgment Class Electricity, Regulating &c.], the two motors M^1 , M^2 being connected in series and parallel with varying

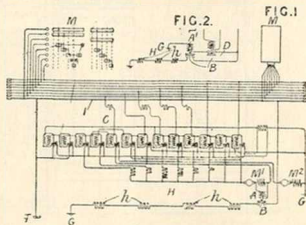

resistance by the controllers M , M . The heating-device H consists of a number of sections h connected to the trolley T by the train-wire 1, and also to the ground G . The circuit is completed through a switch B , operated preferably by an electromagnet A connected in series with one of the motors, or, as shown in Fig. 1, in parallel with the field of one of the motors. The heating-coils are normally energized, but the current through them stops when the core of the electromagnet A is raised by the motor current. In a modification, Fig. 2, a relay D is operated by the motor current, and controls the switch B . When the motor current rises sufficiently, the core of the relay is lifted, thus closing the circuit of the coil A^1 . The core of the switch B is then lifted, and the circuit of the heating-coils is broken.

23,927. Bailey, Sir W. H., and Bailey, A. J. Nov. 5.

Steam traps having counterbalanced vessels are formed with flexible pipe connections, so as to obviate the necessity of steam-tight trunnions or swivels. A simple construction is shown in Fig. 1. As water accumulates in the vessel a , it lifts the counterweight c and depresses the outlet valve h . The inlet and outlet connections are formed by flexible pipes f , g . Fig. 4 shows another trap, in the "empty" position. The counterbalanced vessel a communicates through a pipe g with the chamber of the valve h , the spindle i of which is hollow and carries a piston j , of larger area than the valve k , working in a cylinder k . An auxiliary valve p , controlled by the pivoted arm b , is fitted, ports o , n respectively connecting the spaces above and below it with corresponding

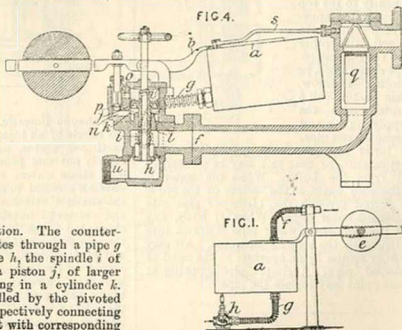

parts of the cylinder k . Other ports l , r respectively establish communication between the drain pipe f and the space below the piston j and between the interior of the valve spindle i and the upper part of the cylinder. The fall of the vessel a causes the valve p to open, thus establishing communication between the space below the piston

and the exhaust pipe u , and relieving the pressure below the piston. The valve h is then free to open under the steam pressure, allowing the trapped water to escape. A flexible pipe s connecting the top of the vessel a with the steam pipe allows any air entering to pass back into the steam pipe. A strainer q is also provided.

23,943. Gremmels, K. E. F. Nov. 5.

Heating buildings; heating by steam circulation.
 —Regulation of the pressure, and hence of the temperature, of steam in heating systems is effected by the introduction of narrow throttle pipes within the separate radiator supply pipes. Fig. 3 indicates an adjustable form, in which the socket r can slide along the inner tube d and can be clamped in position by a nut o working on a conical thread on the split end p of the socket. In a simpler form, the adjustable part r is omitted, the

inner tube d , which may be nozzle-shaped, being alone retained. The method of fixing to the steam-supply pipe l is shown.

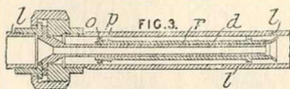

24,356. Wallace, C. W. Nov. 10.

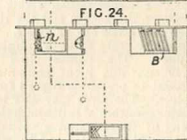
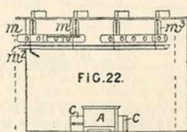
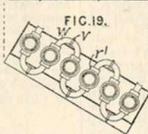
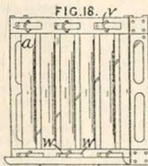
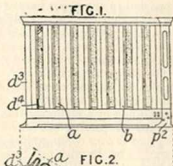

Heating air; heating buildings &c.—In a system of heating or ventilating rooms, halls, and the like, the humidity of the air in the rooms or the like is regulated by the employment of special forms of radiators, heating-pipes, and arrangements thereof. Two forms of radiators are shown in Figs. 1 and 2 and Figs. 18 and 19, respectively. Figs. 22 and 24 show one wall of a hall or other apartment fitted with heating and ventilating appliances. The other Figures show details of constructions. The radiators are formed of metal tubes b and porous tubes a arranged alternately. The metal tubes b may be provided with ribs d having extension pieces d' . Wire netting or a wire frame may be inserted between the pieces d' . Each porous tube, as shown in Fig. 3, has a central tube h which is open at its upper end and connected at its lower end to a water-outlet pipe p' , Fig. 1, by a passage p located in a bottom piece, as shown in Fig. 11.

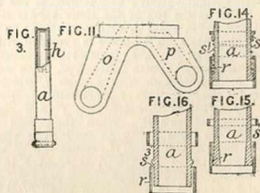

This Figure also shows the passage o by which the annular space between the inner tube h and the

outer porous tube is connected to the water-supply pipe σ^1 , Fig. 6, passing through the bottom piece. The outer porous tubes are connected to the bottom pieces by rims or joint connections r , several

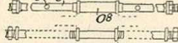
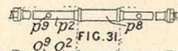
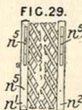
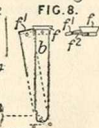
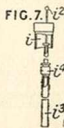
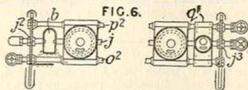

forms of which are shown in Figs. 14, 15, and 16. Filling s^1 of plaster of Paris, leather, india-rubber, or the like, or a compression spring s^1 , may be placed between the tube a and the rim r , which then receives a screw cap or ring s . The ring r may be made separate from, or integral with, the bottom piece. The porous pipes may have interior linings, Fig. 9, of perforated or galvanized metal to prevent a deposit from forming on the pipes. The pipes may also be provided with exterior wirework α^9 to diminish the breakage. At the end of the radiator, a special pipe i is provided to regulate the level of the water in the porous tubes. This pipe, shown in detail in Fig. 7, is provided with an inner tube i^2 which passes through a stuffing-gland i^1 and is open at the top. The height of the top of the inner tube is regulated by a rod i^3 , which passes through a cap on the top of the tube i . The tube i is provided with a bottom piece g^1 , Fig. 6, by which it communicates with the flow and return tubes σ^1, σ^2 . The metal tubes b communicate with a pipe j , which is secured to the framework of the radiator at opposite ends by left-hand threaded nuts j^2 and right-hand threaded nuts j^1 . When these nuts are loosened, the pipes b may be inclined as shown in Fig. 8. A top piece f^1 , connected by rods f^2 or the like to the top f , is adapted to fit over the top connecting-pipe of the pipes b so as to hold the pipes in an inclined position. Figs. 31 and 32 show alternative forms of pipe connections p^2, σ^2 . The inner tubes σ^1, σ^2 extend the length of the radiator, the outer tubes σ^1, σ^2 serving

to space the bottom pieces apart. The inner tubes, which have holes σ^1, σ^2 for water communication with the bottom pieces, end in shoulders so that they may be clamped in position by nuts. As shown in Fig. 32, the pipes σ^1, σ^2 are adapted to be fitted in short lengths between the bottom pieces. The pipe σ^1 is formed of two parts, one part σ^1 being connected to the other through a screwed cap σ^3 engaging the nipped end of the part σ^1 . The last section of piping has its ends screwed in the same direction instead of in opposite directions as in the case of the intermediate sections. In the other form of radiator, shown in Figs. 18 and 19, porous tubes a are connected through T-pieces r^1 to quadrant-shaped tubes u , which are united by flanges v . The tubes may be lined with a metal casing and non-conducting composition. For ventilating a room or hall, a radiator A and ventilating-box C , Fig. 22, are arranged in front of an air entrance. The air inlet is regulated by the trellis shutter shown in Fig. 29. The trellis is connected by pairs of pins n^1 to side supports n^1, n^2 . The upper pair of pins n^1 connect this trellis to blocks which slide in grooves in the side supports. The tops of the ventilating-box C and radiators A are also provided with hit-and-miss gratings to regulate the admission of hot air to the room. Compound porous heating-pipes m are supported in the upper part of the hall above a trough m^2 which catches any drip water. The pipes m have inner perforated pipes m^1 through which the water supply passes. The compound tube m is supported above the trough by a cross-piece fixed to the supporting-bracket m^3 . In the arrangement shown in Fig. 24, a radiator B , which may have inclined tubes, is arranged in front of the air outlet controlled by a trellis shutter n . The room may be cooled by passing the air on its way to the ventilating-box C over cooling-pipes arranged in the basement. The Provisional Specification also describes a system of ventilating underground passages and spaces by placing hot-water radiators of the above-described construction in the upcast and downcast air flues. Where a warehouse or the like is adjacent to a set of boilers used at intervals, the apparatus described above may be provided with extensions of the porous pipes, which may be shut off when not required.

24,449. Nesbit, D. M., and Ashwell & Nesbit. Nov. 11.

Heating buildings etc.—Radiators for steam or hot-water heating systems are mounted on trunnions to render the space behind them accessible. Fig. 2 shows the invention as applied to a system in which air from a flue k is passed through the radiator a into the apartment. The trunnions c forming the steam or water connections, and fitted with stuffing-boxes, are supported by adjustable yokes f , which form bearings upon which the trunnions rotate. A chain m , which may be attached to a counterpoise o or to the wall, limits the rotation of the radiator. A bar p across the flue opening supports the radiator in its normal position, and a safety detent l prevents accidental displacement.

1904]

ABRIDGMENT CLASS HEATING.

Rotation of the radiator into the position shown in dotted lines renders the flue accessible for cleaning without disconnection of the system. As

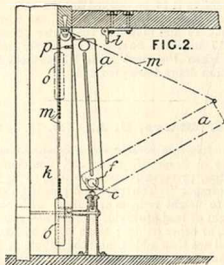

applied to radiators for heating apartments in the ordinary manner, the yokes *f* need not be adjustable, while the counterbalance may be replaced by a coiled spring.

24,499. Lancaster, E. W. Nov. 12.

Heating water.—A water-heater in connection with baths, lavatories, and the like consists of a series of sheet-metal vessels, provided with baffles and internal distributors, and arranged vertically in a double-walled casing.

The conical discs *k*, *n*, tapering inwardly flanged at their inner and outer edges, are arranged, as shown in Fig. 1, on a vertical rod *r*, inside a double-walled casing, the annular space being filled with asbestos or other non-conducting material. The lower discs *k* are additionally flanged to form alternating baffles *w*. The upper part of each chamber contains a corrugated, conical deflector *p*, and the water inlet and outlet pipes *p*, *q* are screw-jointed to permit the removal of the heater from the casing. A sediment-collector *u*, gas or petroleum burners *c*, [a

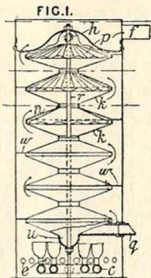

flue *f*, and air-outlet holes *e* are also provided. The casing may be extended to form an airing-chamber at the top.

24,760. Boyd, R. W. Nov. 15.

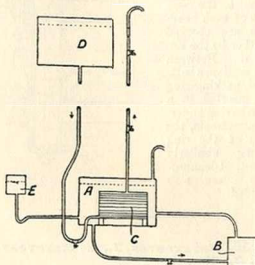

Heating water.—In a hot-water supply system, the water is heated in a tank or coil of pipes *C* placed in a reservoir *A* in communication with the kitchen or other boiler *B*. Water is supplied to the tanks *C*, *A* from the cisterns *D*, *E*, the water levels in which are kept constant.

24,801. Anderson, J. C. Sept. 19, [date applied for under Patents Act, A.D. 1901].

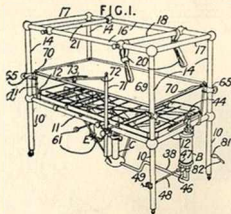

Bed warmers and airers.—A bedstead for invalids is formed with a tubular framework 10, 11, 12, 14, 16, 17, adapted for the introduction of hot water or steam through a nipple 81 and tube 82, for heating purposes.

24,829. Miller, G. F., and Kronier, J.
Nov. 16.

Heating water.—In boilers formed of water tubes which connect cylindrical head-pieces *b*, the sections of each head-piece are secured together by the tie-rod *d*. Between each section, a soft-metal packing-ring *f* is inserted in a recess having undercut abutments, the edges of the ring being similarly shaped. Cleaning-plugs *i* are also provided.

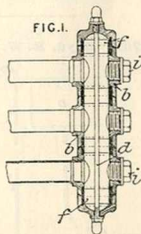

carries a cam 15, and rotates within an extension 11 of the valve casing 2. A double valve, Fig. 3, is employed, of which the inner one 8 is first opened by the cam on the fall of the float, thus equalizing the pressure upon the larger valve 5, and enabling it to be opened by the cam. Steam and water from the inlet 3, Fig. 1, can then enter the float 14 and blow out the water through the outlet 17 until the float rises and again closes the valve, when the float again commences to fill. Inspection doors 4 are provided.

24,038. Hargreaves, J., and Hargreaves, H. J. Nov. 17.

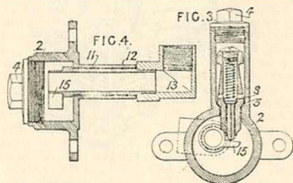
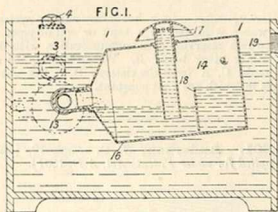

Steam traps.—The trap consists of a vessel 1 having an outlet 19 and containing a float 14, which is provided with an inlet 16 and an outlet 17, and is fitted with an internal partition 18 so that it always retains a certain quantity of water. Any motion of the float is communicated by means of an elbow joint 13 to a hollow shaft 12, Fig. 4, which

25,128. Marga, U. A. Nov. 18.

Non-conducting coverings and compositions.—Relates to a fireproof, acidproof, non-conducting insulating, preservative composition, to be known as "Refragor." Ten parts of powdered asbestos heated to bright redness are mixed with one part by weight of lead protoxide or binoxide, manganese dioxide, or other oxides; three parts of linseed oil or other oil are then added, and the whole is mixed. The resulting paste, owing to the oxidation of the oil, which may be quickened by adding virgin cellulose and heating, hardens on standing, and is then mixed with alcohol and ether or other solvents to soften, when it may be pressed or rolled into a metallic cloth. Articles manufactured from the composition are improved by being dipped in dilute sulphuric acid, or by heating the oil to 250° and adding the oxidizing-agent. The composition can be used for carriage panels, partitions for buildings, ships, coverings for floors and buildings, &c.

25,304. Raps, N. J. Nov. 21.

Heating buildings &c.; footwarmers; steam traps.—In a system for heating railway carriages by steam from the locomotive, the steam is distributed at high pressure along the train by a large well-lagged pipe 1, Fig. 1, from which it passes through a reducing-valve 4 on each carriage to a pipe 6 leading to radiators 8 and footwarmers 9. A return pipe 10 for collecting condensed water is connected to a steam trap 11 and to an automatic discharge valve 12, which allows air and water to escape when starting the apparatus or after use. Steam traps 5 and similar discharge valves are also connected to the main pipe 1. The radiators consist each of two casings 13, 14, Fig. 4, connected by tubes 15, 16, between which the steam circulates, entering at one end and leaving at the other. Vanes 16^a are fitted over the outer tube. The radiator may have a valve 25, actuated by a rod 28, for regulating the admission of steam and the discharge of water of condensation, and a vent valve 21 for admitting air. The footwarmers consist each of two casings 32, 33, Fig. 6, united by a flattened tube 34 covered by a striated plate 35, on which are riveted sufficient brass plates 36 to keep a temperature of 75° on the surface. The space containing the footwarmer is lined with sheet lead 37. A cock on the locomotive for admitting steam to the main pipe consists of a plug 83,

Fig. 13, working in a casing 81 connected at 82 to the boiler, at 86 to the main pipe, and at 87 to an exhaust pipe. The cock can be turned to connect the port 86 either to the boiler or to the atmosphere, or to blank it and thus retain a certain

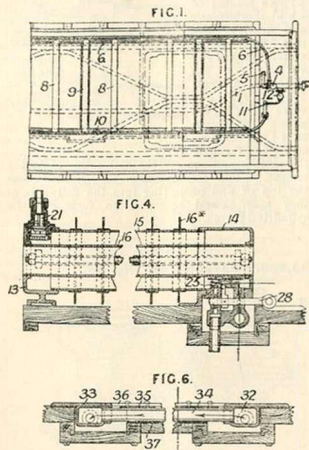

amount of steam in the main pipe. The plug is held down by a cap 89, a metal ring 88 and a number of regulating-washers 90 being interposed. The reducing-valve for supplying steam from the main pipe to the branch pipe on each carriage consists of a piston valve 70, Fig. 11, connected to a spring-controlled piston 66, and controlling the connection between the main-pipe port 65 and the branch-pipe port 6. The steam admitted to the branch pipe 6 also has access to the top of the piston 66, and shuts off the valve 70 when the pressure reaches the required limit. A chamber 79 below the valve is connected to the atmosphere by the pipe 80, and to the space below the piston 66 by a port 78. A safety-valve 76 and a vent valve 77 are fitted above the piston 66. The steam trap consists of a spring-pressed slide valve 43, Fig. 8, connected by a frame 42 to a curved tube 39, fixed at 40, all enclosed in a casing 38 connected at 49 to the drainage pipe of the system. As soon as the casing becomes filled with water below a certain temperature, the tube contracts and opens the valve. A pipe connection 50 protected by a strainer 51 connects the trap to the

port 55, Fig. 9, of the automatic discharge valve 12. This valve consists of a piston valve 54 connected to a spring-controlled piston 53, the space above which is connected by a passage 63 with the

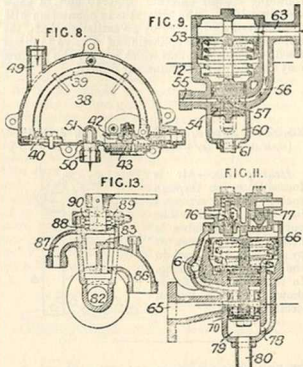

main pipe, while the space below is connected by a port (not shown) to the space 60 below the valve, which space is connected to the atmosphere by a pipe 61. Before the admission of steam to the main pipe, the valve connects the port 55, and a port 56 connected to the port 63, to a port 57 leading to the space 60, and allows water to escape. As soon as the pressure in the main pipe reaches a certain limit, the piston 53 closes the connections.

25,502. Junkers, H. Nov. 23.

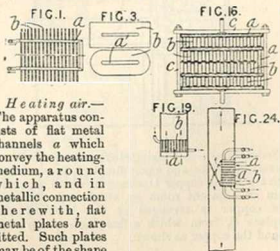

Heating air.—The apparatus consists of flat metal channels *a* which convey the heating-medium, around which, and in metallic connection therewith, flat metal plates *b* are fitted. Such plates may be of the shape shown in Fig. 3, or of crinkled, curled, or of other suitable form, as

shown in Fig. 16. The air to be heated is blown through the flat spaces between the plates by a fan, which may be driven by a turbine actuated by the heating-medium employed, a mantle or casing *c* confining the air current. Figs. 19 and 24 show the disposition of the apparatus in connection with a current of air induced by a ventilating-shaft, the latter showing the application of a valve to direct the flow. The channels which convey the medium may be fitted with stiffeners if desired.

25,520. Mare, F. de. Nov. 23, A.D. 1903, [date applied for under Patents Act, A.D. 1901].

Heating air.—Air is forced by a fan through conical tubes *C* arranged in a casing *B*. The outside of the tubes is heated by flue gases, or by burners *D* placed in the bottom of the casing. In the Figure, the fan is shown driven by an electromotor *O*.

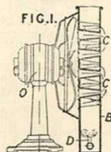

25,599. Habershon, A. Nov. 24.

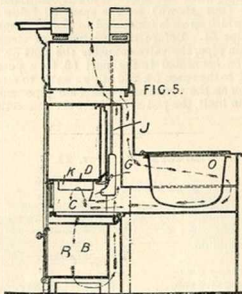

Boiling-pans.—A cooking stove or range, with a convertible close and open fireplace, is combined with a washing copper *O*, access to which is gained from an adjacent room in which it is situated. The copper is arranged at the back of the fireplace *O*, from which a flue leads under and around the copper as shown.

25,618. Gold, E. E. Nov. 24.

Steam traps.—The screens *M, N*, placed at the entrance to the pipes leading to the thermostatic and gravity traps in a steam-heating system for railway vehicles, are cleaned at intervals by opening a valve *O*, which allows the steam to flow rapidly across and through the screens and remove the dirt collected by the screens. The screens may be situated near the top of and projecting into the fitting *L*, or they may extend across it to form a single cylindrical screen.

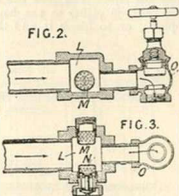

25,653. Parsons, R. Nov. 25.

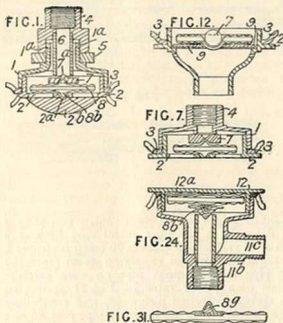

Steam traps.—Relates to steam traps of the type shown and described in Specification No. 8634, A.D. 1902, in which the valve is actuated by the expansion of a flexible condenser chamber containing a volatile liquid, and consists in improvements in the construction and mounting of the chamber and the valve-piece, in the provision of a grit separator or strainer in the inlet to the trap, and in arrangements for blowing through the trap without altering its adjustment. Numerous modifications are described and illustrated. The trap shown in Fig. 1 consists of a body 1, threaded to receive a perforated cap 2, and formed with an extension 1^a on to which a connecting-piece 4 and lock-nut 5 are screwed. The connecting-piece

carries the inlet tube 6, the lower end of which forms a seat for the valve 7, which is kept in place by a projection 8 on the condenser chamber 8 fitting into a recess 7^a in the valve. A similar projection 8^b on the other side of the chamber fits into a recess 2^a in the perforated cap. Adjustment may be made by the piece 4 or the cap 2, a lock-nut 3 being fitted to the latter. Radiator bars 2^b may be provided to render the trap sensitive. In one modification of this trap, the connecting-piece 4 and, if desired, the inlet tube 6, form part of the body of the trap; or the inlet tube may be dispensed with, as in Fig. 7. Adjustment is made by the cap 2, here shown without the bars 2^b. A modified construction of valve is shown in this Figure. In Fig. 12 is shown a form of trap in which the condenser chamber is supported by a bar or bars 9, or an equivalent perforated plate, resting on a shoulder formed on the cap, which is shown funnel-shaped for the attachment of a drain tube. The condenser chamber is recessed for the reception of a spherical valve 7. The supporting bars or plate 9 may be dispensed with by constructing the condenser chamber with its lower face rigid instead of being flexible. In each case, provision is made for the escape of the water of condensation around the periphery of the chamber. Figs. 17, 21, and 24 illustrate the application

pressing directly upon the condenser when screwed in for adjustment purposes. Fig. 21 shows a trap having such a cap, but in this case having a boss 12^a into which screws a spindle 12^b, provided at its lower end with a disc 12^c or equivalent radial arms. In Fig. 24, the inlet 11^b and the outlet 11^a are shown arranged at right-angles. The perforated cap 12 has a thin metal disc 12^a which presses upon the whole of the solid parts of the cap. The projection 8^b of the condenser chamber is shown filled with solder or other metal to prevent leakage of the liquid should the casing wear. The same object may be attained by the use of a conical covering-piece. Other improvements in the valve and condenser chamber not already indicated consist in the use of internal plugs or distance-pieces of various kinds to prevent undue distortion of the chamber, or rupture due to careless adjustment. Two such forms, which are preferably secured to one diaphragm, are shown at 8^c, 8^d, in Figs. 31 and 33; but, in cases where it is merely desired to support the walls, recesses 8^e in the chamber are adapted to receive projections 2^c, 7^b. Fig. 43, on the casing and valve, or may be filled with solder, as in Fig. 42. In some cases, a plate

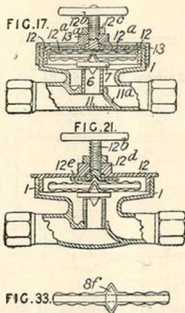

to lift steam traps. In Fig. 17, the trap-body 1 carries a tubular piece 11, which is divided by a web 11^a into inlet and outlet compartments, this web carrying the inlet tube 6. A cap 12 to which a plate 12^a is attached screws into the body 1, and a bossed cap 13 screws outside it, a spindle 12^b on the cap 12 screwing into the boss 13^a on the cap 13. A lock-nut 12^c is fitted. The boss 13^a may be carried by radial bars secured to the body 1 in any convenient manner. The valve 7 here shown may be reversed when one face becomes worn. This constructional form may be modified by the omission of the external cap 13 and the screwed spindle 12^b, the inner cap 12 being closed, and

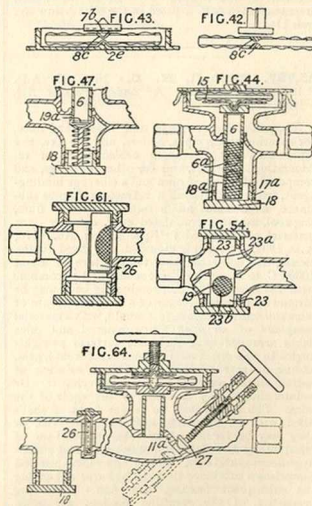

is placed between the valve and the chamber to distribute the pressure due to the expansion of the latter. Such a plate is shown at 15, Fig. 44, in

connection with a trap to which a grit separator is fitted. A wire network is wrapped around or placed inside the inlet tube 6, which may be perforated as at 6^a. A screwed cap 18 allows the accumulated grit to be blown out through apertures 18^a, 17^a in the cap and casing respectively. Fig. 47 shows the application of a sieve-like separator 19^a, which is spring-pressed upon the end of the inlet tube. A form constructed apart from the main body of the trap, and detachable therefrom, is shown in Fig. 54, in which is fitted a tubular piece 23 having apertures 23^a, 23^b, of which the latter are covered by wire-gauze windows 19 in a bucket placed within it. Other obvious modifications are mentioned, in one of which the separator is formed by a gauze pocket, the outlet of which may be closed by a screw-down valve. Fig. 61 shows a further modification, in which the water of condensation passes through a gauze-covered opening in a semicylindrical plate 26 before entering the trap. An arrangement for blowing through without altering the adjustment consists, as illustrated in Fig. 64, in the provision of a valve 27 screwing down on to a seat in the web 11^a. A plane separating-plate 26 is here substituted for the curved one of Fig. 61. In an alternative arrangement, a cock is fitted to the inlet below the web 11^a.

25,787. Michell, H. C. Nov. 27, A.D. 1903, [date applied for under Patents Act, A.D. 1901].

Non-conducting coverings, and blocks and slabs, for covering steam pipes, boilers, and the like, the pipes used for conveying cooled brine in refrigerating-apparatus, and for other purposes, and composed of flakes of mica and a siliceous binding-agent, with or without a refractory fibrous substance, as asbestos and a felting of wood fibre, slagwool, asbestos, granulated cork, or other open material as described in Specification No. 4970, A.D. 1901, after being moulded and dried in the mould, are subjected to a temperature of about 1000° C. to cause the siliceous material to combine with the mica. The non-conducting body may be formed by covering a layer of a viscous mixture of mica and sodium silicate, in a mould, with a material composed of an open filling-material and mica flakes arranged with their flat surfaces at right-angles to the direction in which heat would pass, adding a layer of mica, pouring a solution of sodium silicate over the whole, and drying it. Or sodium silicate may be added to the whole of the mica. The bodies may be in the form of shells filled with an open non-conducting material, or they may be formed of an intimate mixture of mica, filling-material, a binding-agent, and a non-hygroscopic substance. When the filling-material comprises a substance that will be burnt out during the subsequent heating, the non conducting properties of the resulting product are often enhanced.

25,788. Michell, H. C. Nov. 27, A.D. 1903, [date applied for under Patents Act, A.D. 1901].

Non-conducting coverings and blocks and slabs, for covering steam pipes, boilers, and the like, the pipes used for conveying cooled brine in refrigerating-apparatus, and for other purposes and composed of asbestos and a siliceous binding-agent, with or without other ingredients, after being moulded and dried in the mould, are subjected to a temperature of 1000° C. or thereabouts, to cause the siliceous material to combine with the asbestos. The non-conducting bodies may be built up by distributing a solution of sodium silicate over a layer of loose asbestos, or by intimately mixing the asbestos and the silicate solution. The bodies may be in the form of shells, filled with mica and open filling material of the kind described in Specification No. 4970, A.D. 1901, or with other non-conducting material; or they may be formed of an intimate mixture of asbestos, filling-material, a binding-agent, and a non-hygroscopic substance, moulded to shape as described in the above-mentioned Specification. When the filling-material comprises a substance that will be burnt out during the subsequent heating, the non conducting properties of the resulting product are often enhanced.

25,817. James, W. Nov. 23.

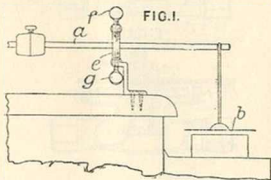

Thermostats.—The heat-regulating mechanism of incubators is arranged to ring an electric bell when the temperature rises or falls beyond certain limits, means being provided for regulating the maximum and minimum temperature and for preventing the regulating apparatus from being damaged when the attendant is absent. The rod *a*, which is moved by the regulating-capsules and carries the damper *b*, passes through a slot in an attachment *e*, and completes the electric circuit when it touches either of the adjustable screws *f*, *g*. The slot is lined with insulating-material, and the upper screw *f* is fitted with a spring buffer, so as to allow the rod *a* to continue to rise after the alarm is given. The screws *f*, *g* are secured by set-screws.

25,843. Law, R. Nov. 28.

Thermostats for incubators and foster-mothers. An electric circuit on being closed by a thermometer in the egg drawer causes an electromagnet *e*, Figs. 1 and 2, to lift by means of a lever *l* a snuffer *m*, Fig. 5, round the lamp wick so

as to lower it, or, as shown in Fig. 2 to raise the damper *m* off the flue leading through the boiler. A set-screw or adjustable counterpoise may be mounted on the lever. The armature is prevented from sticking to the magnet by a small brass pin, set-screw, or prepared paper. The thermometer *a*, Fig. 3, has the wires arranged to complete the circuit at a temperature of 103° F. for the incubator or 70°-90° F. for the foster-mother, and is preferably packed with brass or copper turnings *h* in a metal casing *g* and held in position by cork or asbestos packing-rings *i*, the wire *b* passing through a plaster-of-Paris plug *k*. A solenoid and soft-iron

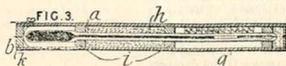
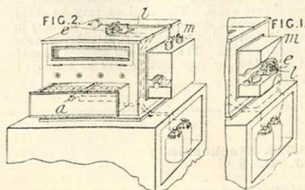
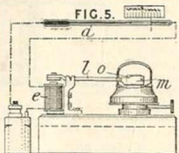

core may be used instead of the magnet and armature. A portion *o* of the snuffer *m* is cut away to leave a small pilot flame.

25,920. Slack, H. Nov. 29.

Boiling-pan.—The gas-heated boiler, shown in section, for laundry and domestic use, is constructed of a bottom casing *A* having three projections, such as are shown at *B*, forming feet, a main casing *P* provided with a door *O* for lighting the burners *N* within it, a boiling-pan *D* supported on this casing, and a top casting *E* fitted with a hinged door and formed with a groove *F* and an outlet piece *H*. The outlet communicates through an opening *I* with the boiling-pan, and through a hole *K* with the interior of the casing *P*, so that the steam and products of combustion escape by one outlet. The various parts are secured by b-tilts, as at *G*, *C*, *L*.

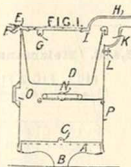

is thus obtained. The coil *C*, Fig. 1, is shaped so that the highest part *c'* of each convolution is at a

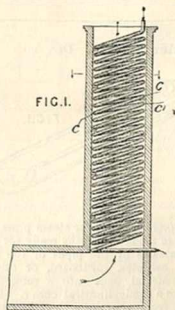

higher level than the lowest part *c* of the coil next above.

25,966. Davis, E. W. Nov. 29.

Heating liquids. — A helical coil of piping is placed in a flue or chimney of a boiler furnace or in any chamber through which a heating-medium is passing. Water or other liquid is forced through the coil in the opposite direction to the current of hot gas &c. Hot water or other liquid or steam

26,067. Coates, F. J. Nov. 30.

Footwarmers; bed-warmers; hot-water bottles.—The parts *a* of a sectional bed or foot warmer

are fastened together by passing a pin *d* through eyes *c, c*, on the edge of each, thus forming a hinged connection. The sections may be filled through separate stoppers *b, b*, or from an opening in one only, connection between the parts being made by flexible tubes. The whole can be used opened out or folded, or each section may be employed separately.

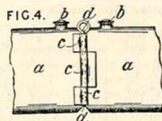

26,278. Mackenzie, J. Dec. 2.

Heating air for use in the concentration of sulphuric acid. The air is led through the tubes *K* in the heating-chamber *E*, which is provided with a bye-pass *G* and dampers *H, J*, so that the furnace gases can be passed directly around the tubes *K*, or not, as desired. A secondary supply of air may be admitted to the chamber *E* by the door *T*, or to the bye-pass *G* by the door *L* to complete the combustion of the gases.

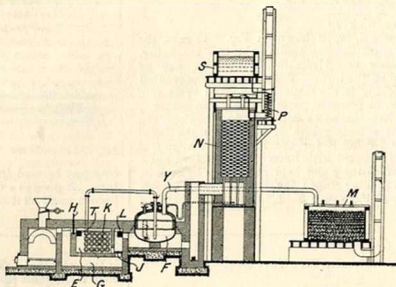

26,465. Illemann, R. Dec. 5.

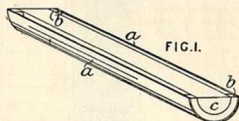

Non-conducting coverings for steam pipes, boilers, and the like are made in lengths ready for application to the outsides of the pipes or the like. A board *a* of asbestos, cardboard, or other non-conducting material, bent into a semicylindrical shape, encloses a semicylindrical core *c*. The core is separated from the outer board *a* by semicylindrical rings *b*. The space between the board *a* and core *c* is filled with silicate cotton (slagwool), astestos, hair, or like non-conducting material. After removing the rings *b* and core *c*, the moulded silicate cotton or the like is damped with an adhesive solution. A covering of asbestos, paper, cotton cloth (calico), canvas cloth, or the like is then pasted or applied over the whole surface of the silicate cotton and the outer board *a*.

26,478. Heizmann, J. Dec. 5.

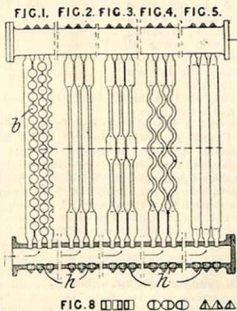

Heating liquids and gases. — In apparatus for cooling, heating, superheating, and other purposes, tubes having a common supply and a common discharge pipe are formed with indentations or

flattened portions and are disposed so as to occupy little space and also to form narrow channels for the passage of cooling or heating fluid and so to render the interchange of heat more efficient. In the superheater shown, the tubes may be arranged to have circular passages *b*, Fig. 1; or they may be flattened in the middle, leaving long uniform passages as shown in Figs. 2, 3, and 5; or this flattened portion may be corrugated, leaving passages of the shape shown in Fig. 4, or of the same shape as the tubes; or the indented tubes may be bent into helical form. Tube sections not circular are shown in Fig. 8. Ribs may be provided on the tubes. A series of tubes may be divided into sets by partitions in the supply and discharge pipes, the contained fluid passing in succession in opposite directions along the sets of tubes. Plugged openings *h* are formed in the supply and discharge pipes for convenience in fixing the tubes.

26,525. Roy, R. P. Dec. 6.

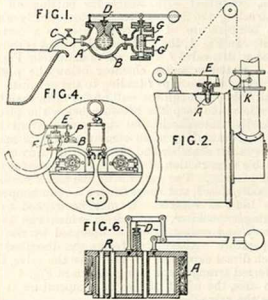

Thermostats.—The apparatus consists of arrangements of levers or pulleys actuated by mercury or other expansible fluid or material. The levers are weighted or spring-actuated, and may rise or fall over an index to indicate or record the variations of temperature, or may operate valves or dampers. For controlling the temperature of a mixture of hot and cold water supplied to baths or the like, a vessel A, Fig. 1, containing mercury or other readily-expansible fluid, is placed in a chamber B through which the mixture flows to the discharge cock C. As the mercury or other material expands, a rod D, sliding in a packed orifice in the vessel A, rises and causes a valve F to rise and partially close the hot-water inlet G and partially open the cold-water inlet G'. The leverage, or the weight on the lever, may be adjusted. When the desired pressure in a boiler is attained, the expansion of the apparatus A, Fig. 2, raises a lever E, and causes a weighted lever K to operate a butterfly valve for controlling the supply of gas or other fuel. A

similar arrangement may be made for operating hinged or lifting dampers for boilers and economizers. In apparatus for regulating the working level of water in steam boilers, a vessel B, Fig. 4, containing liquid expanding material, is placed inside the boiler and connected to a pipe P. When the water is low, the temperature of the steam will raise the temperature of the expanding material which, by its expansion, will cause a lever E to rise and allow a check valve F to work. By arranging the opening of the pipe at the low water level, steam may pass to an expander and cause it to lift a valve, and then pass to a whistle; or the movement of the lever may be used to work other alarms. This arrangement may be applied to domestic and other uses. For regulating the temperature of rooms, a liquid expanding material is placed among tubes B, Fig. 6, in a chamber A. From a rod D, motion is given to levers for operating the starting-switch of an electromotor for driving an air-circulating fan.

26,525A. Roy, R. P. Dec. 6.

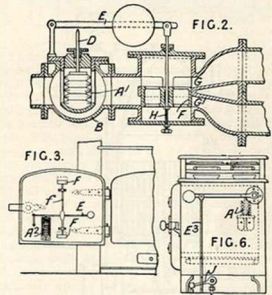

Thermostats.—Several applications of a thermostat, consisting of an expansible tube, are described and illustrated, Specification No. 26,525, A. D. 1904, being referred to. In the arrangement shown in Fig. 2, a tube A', constructed of centrally-pierced metal diaphragms united in pairs at their peripheries, regulates the temperature of the superheated steam passing through a chamber B by means of its connection through a rod D and a lever E with the spindle of the valve F which adjusts the supply of superheated and wet steam through pipes G, G' respectively. The adjustable screw pin H prevents the abnormal descent of the valve F when the steam supply is cut off. This arrangement is stated to be equally applicable for admitting steam from the high pressure valve casings of engines to low pressure casings. A similar arrangement may control the water supply to hand basins, and a modification is also applicable as a reducing-valve. In the construction shown in Fig. 3, the tube A' is secured to the door of an

oven and controls the ventilating-dampers F by means of a lever E and slotted bar *f*. This arrangement may also be applied to furnaces, kilns, and retorts. In another construction, the damper admitting the gases to heat the oven is controlled through a suitable system of levers by the tube placed inside the oven, the temperature at which the levers operate the damper being capable of variation. Fig. 6 illustrates means for regulating the gas supply to a cooking-stove. The gas-cock lever J passes through a longitudinal slot in a lever E', which is actuated by lever connection with the tube A'. For regulating the passage of feedwater to a boiler, the check valve is controlled by a system of levers actuated by the expanding tube placed in the interior of the generator at the working level, the valve being opened when the tube is exposed to the temperature of the steam. The invention may also be employed to control the passage of feedwater through an economizer.

26,554. Caspar, C. H., and Fitzgerald, J. P. Dec. 6.

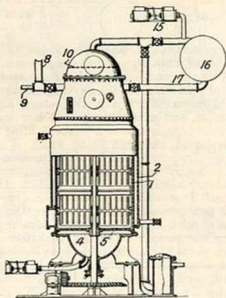

Boiling-pans.—In a process for mashing, applicable generally to making extracts from solid materials, malt and raw grain is fed with water into an airtight, steam-jacketed mash-tun. The materials are boiled under reduced pressure at a temperature at which the saccharifying action of the diastase is most active. Malt, pulverized or ground with rice, corn, grits, &c., is introduced into the tun 1 through an inlet 8 along with water from a pipe 9. Steam is admitted to the jacket 2 and air exhausted from the tun by a pump 15 until the liquid boils at the required temperature (148°-152° F.). The vapours pass into a condenser 16 and the condensation liquid is returned to the tun by a pipe 17. When the extraction and conversion are complete, water is pumped through a pipe 4 at the base of the tun, and, rising through the perforated bottom 5, forces the wort through a filter 10 extending across the interior of the tun.

26,556. Hunter, E. H. Dec. 6.

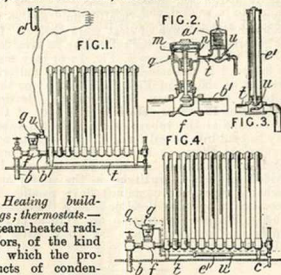

Heating buildings; thermostats.—Steam-heated radiators, of the kind in which the products of condensation are drawn off by an exhaust pipe, are fitted with means for cutting off or obstructing the flow of steam automatically when the temperature of the room rises to a certain limit. In Fig. 1, the steam-supply pipe *b* is shown fitted with a valve *f*. The valve shown in Fig. 2 has a piston *m* and a chamber below the piston connected to the pipe *t* leading to the exhaust. A small hole *g* through the wall of the valve chamber is sufficient to keep the pressure below the piston normally atmospheric, but does not prevent the piston from sinking when communication is made between the chamber and the exhaust. Any other suitable construction of valve may be used for the same purpose. The valve *u* on the pipe *t* remains normally closed, and opens when a certain temperature limit is reached. It may be worked by a sucking-solenoid *a'*, wires from which run to a battery and contact-maker *c'* operated by rise of temperature. Alternative forms are described in which direct expansion by heat lifts the valve, the preferred arrangement being shown in Fig. 4. In each case, the effect of rise of temperature is to close the valve *f*.

26,578. Barham, A. S. Dec. 6.

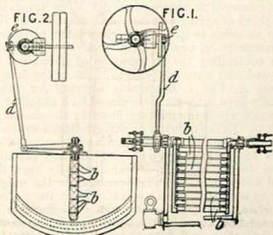

Heating liquids.—A coil of pipes *b*, through

which a heating-medium be circulated, is hung on pivots above the vessel or vat containing the liquid to be treated, and receives a rocking motion through a connecting-rod *d* from a continuously-revolving crank *e*. The bottom of the vat is cylindrical.

26,678. Merton, H. B. Dec. 7.

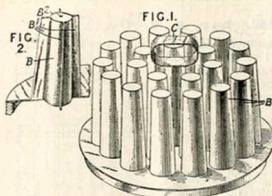

Boiling-pans and similar vessels are provided with means for condensing the steam formed. Fig. 1 shows a lid having a number of condensing-tubes *B*, vertical or otherwise, so placed that the condensation water flows back into the vessel. Any convenient form of baffle-plate may be employed to hinder the escape of steam. The lid may have a handle *C* which projects above the tubes. Fig. 1 shows a modification in which each tube has external ribs *B'* and a hole *B*² in its upper end to allow the escape of air. In another arrangement, the steam is condensed by means of cold water or air flowing through a jacket surrounding the lid or body of the vessel. A number of the vessels may be worked in combination, the water or air flowing successively through their jackets.

26,794. Lindemann, O., [Körting Akt.-Ges., Gebr.]. Dec. 8.

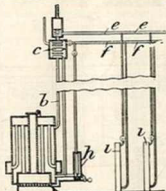

Heating by water circulation.—To increase the circulation, the out-flowing water is highly heated, and is then cooled to a suitable temperature by

part of the returning water. The heated water rises in the pipe *b*, in which one or more checks or constructions may be introduced to prevent back-flow, and before reaching the pipe *c*, which supplies the radiators *i*, is partially cooled in a surface apparatus *c* or a mixing-chamber by part of the water from the return pipe *f*, the remainder being arranged to actuate an automatic regulator *h* of any known type, which controls the air supply to the furnace &c.

26,895. Jones, C. J., and Still, W. M. Dec. 9.

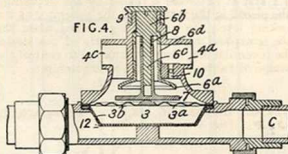

Thermostats.—The gas supply to the burners of the boiler of a hot-water circulating system is controlled by a thermostatic regulator actuated by the inflow of cold water into the system whenever hot water is drawn off. Within the return pipe *c* of the system, and preferably just below the cold-water inlet pipe, is placed a vessel *3* filled with a volatile liquid, one wall *3*^a of which is flexible. The gas valve is actuated by the expansion of the liquid under the influence of the temperature of the return water, which is in contact with the other wall *3*^b or with its protecting-casing *12*. A fall of temperature of the water in the pipe *c* enables a spring *8* to force down a tubular piece *7*, opening communication from the gas inlet *4*^a through ports *6*^a and the valve *6*^a to the gas outlet *4*^c. An adjustable bye-pass passage *10* is kept permanently open. Adjustment of the thermostat is made by the screw *6*^b after removal of a gas-tight cap *9*.

26,924. Hillier, C., and Hillier, A. Dec. 9.

Heating buildings; heating water; boiling-pans.—In a hot-water heating-system, for baths and for heating rooms, conservatories, or the like, the hot-water service for baths may be arranged for heating rooms, the whole system being supplied from a boiler or copper heated by a kitchen range or by a separate fireplace. Fig. 1 shows the general arrangement, and a part of the

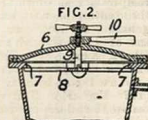

boiler 5 is shown in detail in Fig. 2. The boiler is placed in a flue which communicates with the kitchen range or with a separate fireplace. The boiler is supplied from the cold-water cistern 16

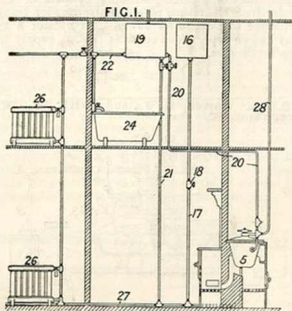

by a pipe 17 in which is placed a valve 18. The outlet from the boiler communicates with the hot-water cistern 19 by a pipe 20. The hot water from the cistern 19 is carried by a pipe 22 to any part of the building, such as the radiators 26 or a bath 24. The hot-water cistern is connected by a

by-pass 21 with the main return 27, which enters the boiler at its lowest point. A vent pipe 28 is also provided. As shown in Fig. 2, the boiler is provided with a cover 6 held in position by means of a bolt 9 which passes through the cover and through a four-armed bridge bar 8 engaging the undersides of lugs 7 cast on the boiler. By closing the tap 18 and removing the cover 6, the boiler may be used for domestic purposes.

26,932. Low, A. N. Dec. 10.

Heating buildings.— Fig. 1 shows a vertical section of a radiator for heating buildings, railway carriages, ships' saloons, and the like by the circulation of steam. Corrugated tubes C, traversed by open air tubes E, are arranged, preferably, in pairs on top and bottom chambers A, B. The steam is admitted through the cock G and pipe F, and descends around the air tubes to the outlet H. A series of such pairs of heating-elements may be connected together by bolts or otherwise.

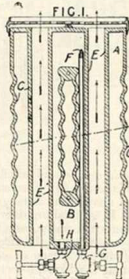

26,949. Mills, B. J. B., [Edison, T. A.] Dec. 10.

Heating by electricity.—In a continuous process for nickel-plating metal strip, the strip is afterwards dried by being heated electrically. It is passed under a pulley 66, Figs. 2 and 4, which is carried by a bracket 70 adjustable on a hanger 71 by means of a screw handle 72. A brush 71' and a lead 73 are joined to a main 57. The strip passes over an idler 67, which is like the idler 40, Fig. 8, being carried by a pin 45 on an angle-iron 44 attached to

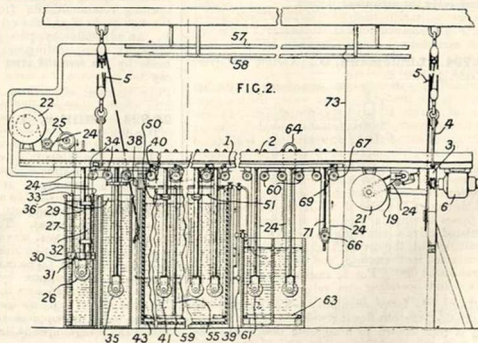

a beam 1, and having a brush 49 connected to a conducting-bar 48. Another brush 69 in advance of the pulley 67 bears against the strip 24, and is carried by a pin 46, Fig. 8, and connected to a bar 48. The two bars 48 are connected to the other main 58. By adjustment of the length of strip between the pulleys 66, 67, any desired heating effect may be obtained.

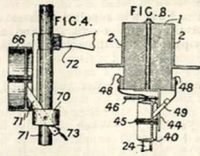

26,961. Sharp, R. N., Ingle, J. H., and Thoratou, H. Dec. 10.

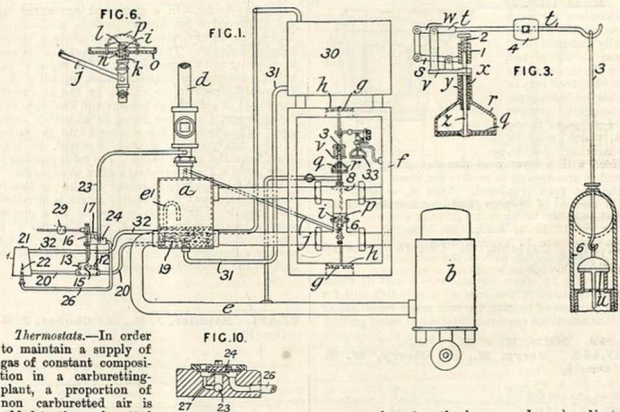

Thermostats.—In order to maintain a supply of gas of constant composition in a carbureting-plant, a proportion of non carburetted air is added to the carburetted air, the amount being regulated by a thermostatic arrangement; the air supply is also heated by warm water, the temperature of which is similarly controlled. In the apparatus shown, a carburettor *a*, divided into air heating and carbureting compartments, is supplied with air from a compressor *b* and with carbureting-liquid in any suitable manner. Part of the air passes through the lower chamber of the carburettor into the upper chamber by the pipe *e'*, and thence by the pipe *d*, while the supplemental air passes through a pipe and a thermostatically-regulated valve *u* situated in a pipe *6*, and thence to mingle with the carburetted air. The regulator is contained in a casing *f*, and comprises a hollow thermostatic disc *q*, Fig. 3, suspended in a framework *r* and operating the valve-rod *3* through a rod *z* and levers *s*, *t* pivoted to a bracket *v* and connected by a link *w*. The framework *r* is provided with a boss *x* which screws into a tubular part *y* of the bracket *v*. The end of the rod *z*

enters a boss *l* on the lever *s* and can be adjusted therein by means of a screw *2*. A weight *4* is also provided for regulating the valve-operating mechanism. The thermostatic disc is heated by a burner *i* connected to the gas outlet *d* by a pipe *j*, and comprises a tube *k* covered with a piece *l* of wire gauze carrying by means of an adjustable nut *n* arms *o* which support a heat-distributing cap *p*. The cap *p* is so adjusted that, when the flame is of the desired quality, it is burning completely beneath the cap, but, if the air becomes too highly carburetted, flame projects above the cap and operates the thermostat. To prevent irregularity of working, a stream of air supplied from the pipe *e* is caused to play on the disc *q* through a perforated hollow disc *8*. The casing *j* is maintained at a uniform temperature by ventilating-arrangements *h*, *g* controlled by a thermostatic disc *35* in the manner of an ordinary incubator. The heating-water is supplied from a tank *30* and circulates through pipes *31*, *19*, *20*, *32*. The water is heated by a cross tube or coil tube boiler *21*, the

burner 22 of which is supplied with gas from the outlet *d* through pipes 23, 26 and a thermostatically-controlled diaphragm valve 24, Fig. 10. A thermostatic disc 12 is situated above a chamber 15 at the bottom of a casing 13, through which chamber the heating-water passes, and the disc operates the valve 24 by means of a rod 16 and lever 17 pivoted to the casing and provided with an adjusting-weight 29. When the valve is entirely closed, a bye-pass 27 supplies enough gas to the burner 22 to keep the flame from extinction.

27,350. Mohn, W. H. Dec. 15.

Heat-retaining chambers &c.—A receptacle specially adapted for use in camps and in factories where cooked food may be delayed before consumption, consists of an outer casing *b*, which may be single or double, lined with a layer *c* of non-conducting material, and so arranged as to receive the vessel *a* in which the hot food is placed. Taps *d*, *d'* permit of the escape of vapour and condensation water respectively.

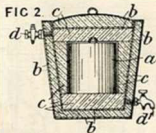

27,440. Carlson, G. Dec. 16. *Drawings to Specification.*

Heating by steam circulation.—A coil of steam pipes is placed in the base of a grinding-mill for the purpose of heating the mill when chocolate or other substance requiring heating is being ground.

27,448. Berry, H., and Berry, W. E. Dec. 16.

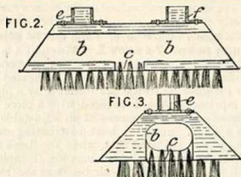

Heating water.—A boiler intended for a hot-water installation, and adapted to be heated by atmospheric gas or oil burners, is constructed as shown in vertical, longitudinal, and cross section in Figs. 2 and 3. The vessel is preferably rectangular in plan, tapering towards the top as shown, and is pierced longitudinally by a flue *b* of relatively large diameter, into which the combustion products gain admittance through the passage *c* in the bottom of the boiler. Flow and return pipes *e*, *f* for the hot water are provided.

27,488. Stidder, J. G., and Cooper, J. E. Dec. 16.

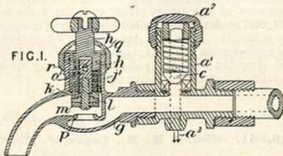

Heating water.—In a combined hot-water tap and safety-valve for kitchen boilers, as shown in Fig. 1, the safety-valve *c* is situated in a lateral tubular casing *a'*. The valve *c* is kept to its seat by a spring and a screw cap *a'*. The casing *a'* has outlet passages on opposite sides, opening in a downward direction, as shown by the arrows *a'*, one to act as a discharge passage and the other as a test passage, the latter being fitted with a screw plug. The discharge tap *g* screws into the casing of the safety-valve; it may, however, be used apart from the safety-valve. The valve consists of three parts *k*, *l*, *m* secured by a screw to a spindle *o'*; the parts *l*, *m* are free to rotate together, so that in closing on the seat *p* a grinding action is obviated. The spindle *o'* is loosely connected by a pin, as shown, to the screw head *h*, and a spring *j'* is interposed. A cap *g* screws on the casing, and a passage *r* through the head *h* drains leakage water back to the interior of the casing.

27,491. Stidder, J. G., and Cooper, J. E. Dec. 16.

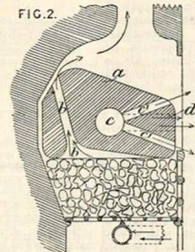

Heating apparatus; footwarmers.—A heat retaining and radiating block or slab for gas fires may be used as a footwarmer and for other purposes. The block *a*, of fireclay or other refractory material, which is placed on the fire, is formed with conduits *b*, preferably inclined, for the products of combustion, with a chamber or chambers *c* having passages *c'*, leading to the front

1904]

ABRIDGMENT GLASS HEATING.

of the block, for the circulation of air. The block is preferably recessed on its underside. It can be removed from the fire, by a poker placed in the hole *d*, and used as a footwarmer.

27,687. Atkinson, R. E. Dec. 19.

Heating buildings; thermostats.—The supply of steam to the radiators is regulated, firstly, by a valve directly controlled by the temperature of, or near to, the radiator, and, secondly, by a diaphragm valve controlled by a thermostat in the apartment to be heated. The first consists of a valve 9, which opens to admit steam to a chamber beneath the second or supplementary valve 2, and may be regulated by the thermostatic arrangement described in Specification No. 12,850, A.D. 1904. The supplementary valve 2 is controlled by a diaphragm 4, of which one surface is under atmospheric pressure and the other under pressure or vacuum communicated by a pipe *m*; the diaphragm is also under the influence of a spring 5 and of a lever 7, which turns the quick-threaded screw 6 and carries a pointer. The general arrangement of a system in which compressed air is employed to actuate the diaphragm valve is shown in Fig. 2. The main *e* is supplied with exhaust steam from an engine *b*, a bye-pass *f* for live steam being also fitted. The diaphragm valves *k* of the radiators are controlled by thermostats *l* which, on sufficient rise of temperature in the respective apartments, actuate valves that open communication between pipes *n*, which convey compressed air from the receiver, and pipes *m* which open above the diaphragms, thus shutting off the supply of steam. A condenser *t*, vacuum pump *s*, and a pump *u* for returning condensed steam to the boiler are also shown. In one modification, the thermostats *l* are arranged to establish communication, on a sufficient fall in temperature, between the chamber above the diaphragm and the return (low-pressure) main of the system, thus opening the supplementary valves. In a further modification, a

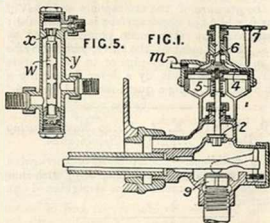
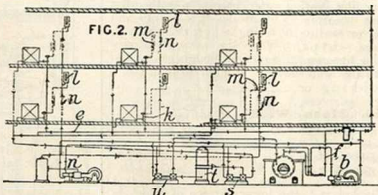

thermostatic valve *y*, Fig. 5, such as is ordinarily employed as an air vent, may be placed in the outlet from the radiator. When the temperature at the radiator outlet becomes too high, a cylinder *w* of expansible material closes the passage *x* by which the vacuum maintained in the return mains is ordinarily communicated to the chamber above the diaphragm, thus enabling the atmospheric pressure beneath it to hold the valve 2 open.

27,707. Michaud, G., and Delasson, E. Dec. 19.

Heating by electricity.—Filaments for incandescent lamps are made of fused silica, alumina, lime, or magnesia, with carbon in the form of a core or otherwise. The powdered material is fed by means of an electric striker *e* from a reservoir *b* through the centre of an oxyhydrogen blowpipe *a* and on to an aluminium cap *d*. As the filament *f* is formed, the cap is withdrawn by means of a screw *c* to which it is attached. Such filaments may be used in air.

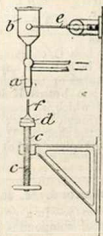

27,777. Atkinson, R. E. Dec. 20.

Heating buildings etc.; heating by steam circulation; heating water.—

The supply of steam in a low-pressure heating system for heating buildings, ships, and the like, and for heating water for cooking or laundry purposes, is controlled by the pressure in the return main by the employment of a diaphragm valve as shown in Fig. 2. The valve proper 2 is actuated by a diaphragm 4, the lower surface of which is under the pressure of the atmosphere and that of a spring 5, while the upper surface is influenced by the pressure in the return main, communicated by a pipe *n*. Adjustment of the valve, which may be placed in the main supply pipe or in the separate radiator inlets, is made by a lever 7 carrying a pointer 8 and operating a quick-threaded screw 6.

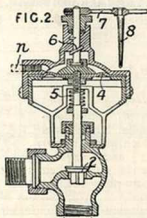

27,799. Boulton, A. J., [Long Manufacturing Co.], Dec. 20. *Drawings to Specification.*

Heating buildings.—Radiators have corrugated gills arranged spirally, the winding being such that the corrugations are more or less straightened out at the outside edge.

27,815. Propert, W. F. Dec. 20.

Heating water.—

A loiler for rapidly heating water for domestic purposes contains an internal, conical firebox fitted with cross water tubes or a spirally coiled pipe, and is heated by a specially-arranged gas burner. The shell *A*, provided with nipples and an inspection hole *C*, contains the conical firebox *B*, which may be fluted in any desired manner. Horizontal cross-tubes or the coil *O* may be fitted, and at the base is a burner *K* in the form of a slot *L*, one side of which is formed by the firebox. Gas is supplied through the pipe *I*, fitted with an air regulator *N*, to the chamber *H* and distributor *J*, which are supported in the firebox by means of the removable stay *M*.

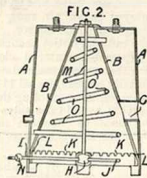

27,907. Blackmore, H. S. Dec. 20.

Heating by electricity.—In a process for making electrothermic chemical compounds, such as sulphur

trioxide, a mixture of gases is passed through electrically heated diaphragms *d*, Fig. 1, of gold-plated copper gauze, which are supported

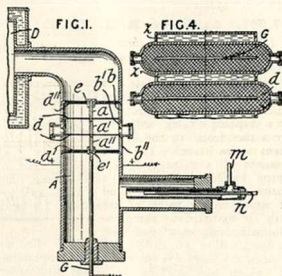

between the screw-threaded segments b^{11} , b^1 , b , and a^{11} , a^1 , a of a chamber *A* and of a conducting-rod *G* respectively. Upper and lower diaphragms d^{11} , d^1 , composed of several thicknesses of gauze, serve as flash preventers and heat absorbers. Fig. 4 shows, in plan, a battery of chambers, a strip of metal replacing the central rod *G*, while interposed water jackets *z* serve for controlling the temperature of reaction.

27,943. Hampton, E. Dec. 21.

Heating buildings

etc.—Various arrangements of pipes for the more equable heating of churches, chapels, public halls, and other similar buildings are described. The middle pews, or other seats, are heated directly, as shown in plan and elevation in Figs. 1 and 2, by means of the pipe *a*, which contains hot water under pressure and is doubled under the seats. In the case of pews with a central partition, two similarly-bent pipes are employed, one on each side of the partition. In heating by low pressure steam or water, a central main *g*, Fig. 8, is fitted with doubled branch pipes. The application of

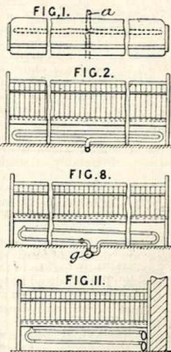

both systems to the heating of the side pews is also illustrated in the Specification, and in Fig. 11 is shown the method of heating such pews by the two-flow system.

28,127. Uthemann, F. Dec. 22.

Heating water.—Tubes of brass or other copper alloy, used in apparatus for heating water, are protected from deterioration by sea-water by the insertion in the tubes of a helically-coiled iron wire, preferably of triangular cross-section. Electrolytic action causes a layer of iron oxide to be deposited on the inside of each tube. After the tube is coated, the electrolytic action ceases and the wire acts as a guide for the water flowing

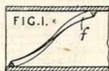

through the tube. The wire may be wound outside the tube. Reference is made to Specification No. 21,561, A.D. 1904, [*Abridgment Class Electrolysis*].

28,139. Kumpf, H. Dec. 22.

Non-conducting coverings.—Comprises non-inflammable felt sleeves which, after pressing and drying, always retain their shape for the insulation of steam pipes and the like. The felt sleeves *a* are saturated in a solution of magnesium chloride or magnesite with aluminium chloride, or cement, or other adhesive substance, and are then pressed into the desired shape. When non-inflammability is unnecessary, the felt is saturated with glue or paste.

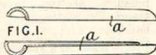

28,162. Mowille, J. L. de., [*Morrison, W. J., and Wharton, J. C.*] Dec. 22.

Heating by electricity.—In an electrically-operated machine for producing fibrous or silky candy, means are provided by which the heating-apparatus is *f* only brought into operation during the action of the machine. The rotary pan *a* is constructed with discs *d*, *e* separated by a band *c* having moderately large perforations. The upper disc *d* carries a conical feeding-hopper *f* open at the top. The electric heating-appliance consists of a fine flat strip of suitable resistant material made into a helix or other form of close mesh to prevent the passage of unmelted particles of sugar. Instead of a simple circular helical resistance, a number of segmental helical resistances may be used. The leads from the heating-appliance are connected to rings *k*, *l* on the spindle *m*, which is driven by any suitable motor *n*. Preferably, a single switch *o* controls

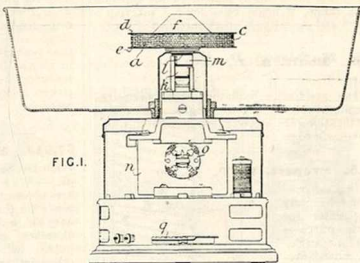

the motor and the heating-apparatus, a rheostat *q* being used to regulate the amount of current passing through the latter.

28,197. Claridge, J. W. Dec. 23.

Heating gases and liquids.—Surface apparatus for heating and similar purposes is formed of one or more elements, each of which consists of a heating-box provided with one or more internal diaphragms. Figs. 1 and 2 show one form of box, in which a diaphragm *b* is located between the inlet *c*

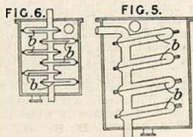
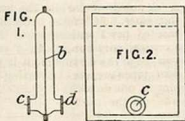

and outlet *d*. Fig. 3 shows a modification of this form. One or more diaphragms may be arranged in a box, as shown in Fig. 4. The elements may

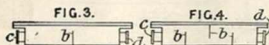

be superposed in a vessel, as shown in Fig. 5, and inclined so as to promote circulation of the fluid surrounding the boxes. Fig. 6 shows a modified arrangement of the elements. The boxes may be corrugated or provided with projections on the outside to permit any deposit to be dislodged. The acting fluid may pass inside or outside the boxes.

28,280. Mewes, R., and Schumann, A.
Dec. 23. *Drawings to Specification.*

Heating gases and liquids.—A surface apparatus is constructed with tubes in the form of hollow

corrugated metal bands, which are made by flattening and bending round tubes.

28,294. Peterson, L. T. June 24, [date applied for under Patents Act, A.D. 1901].

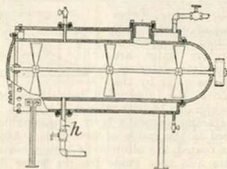

Digesters.—A digester for treating rubber waste is shown in the Figure. It is provided with a steam jacket.

28,396. Mathieson, D. Dec. 27.

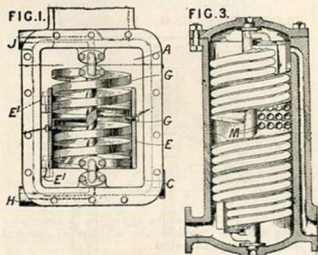

Heating liquids.—Various forms of surface apparatus for heating and similar purposes are described, in which the exchange of heat takes place while both liquids traverse a helical path. In the apparatus shown in Fig. 1, the liquid enters at *C* and flows around the hollow helix *G*, through the interior of which steam passes from the inlet *J* to the outlet *H*. The helix is supported inside the cylinder *E*, which by being hinged to the casing *A* at *E'* can be swung outside for cleaning or repairs. Fig. 3 illustrates a modification, applicable for heating feedwater, in which the steam

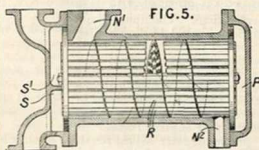

flows through the helical coils *M*, the water passing around them in the reverse direction. Fig. 5 represents a horizontal form of the apparatus, the steam entering at *N'* and taking a helical course to the outlet *N''*, while the water passes through the lower half of the tubes *R* from the inlet *S* to the chamber *P*, returning to the outlet *S'* through the remaining tubes. In a vertical form of the apparatus, the arrangement is similar. The fluid in the tubes, however, traversing the apparatus only once.

28,539. Decauville, E. Sept. 10, [date applied for under Patents Act, A.D. 1901].

Digesters.—Consists in the combination of a heating chamber with an hydraulic press, in which the platform of the latter moves inside the former. This chamber rests through the intermediary of elastic washers, to allow for expansion, on hydraulic rams. The Figure shows a view of the apparatus, the upper and lower entablatures *d, e* of the press being connected by rods *f*, which serve as guides for the vessel *g*. This vessel is mounted upon hydraulic rams *i*, elastic washers *h* being interposed. The bottom of the

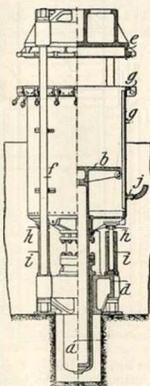

vessel *g* is provided with a stuffing-box, through which passes the piston *a* of the press. The platform *b* of the press moves inside the vessel *g*, which at the commencement of the pressing operation is lowered on the rams *i*, thus allowing the materials to be vulcanized, such as caoutchouc tyres, to be placed in on the platform *b*, this being at its highest position. The rams *i* are then operated and the vessel *g* forced up against the entablature *e*, to which it is then bolted. Vapour is led to the interior of the vessel *g* by means of a tube *j*.

28,683. Robinson, E. Dec. 29.

Heating air.—Fig. I shows an arrangement applicable to heating and humidifying air for warming, drying, or humidifying purposes in mills, factories, and similar places, a part of the apparatus being shown separately in Fig. II. A cylinder *A*, containing heating-tubes connected to end chambers, is provided with a helical baffle *b*, so that air, drawn or forced through the cylinder by a fan *B*, follows a helical path between the tubes. The air may be humidified by injecting a jet of steam into the heater; but, preferably, the air is moistened in its passage through the annular space between two cylinders *e, f*, Fig. II. The outer surface of the inner cylinder, which is heated by steam, is covered with felt or other material capable of absorbing water supplied from the upper part of the cylinder. The air may also pass through moistened sheeting, bunting, or the like

supported by a perforated cage *h* surrounding the closed upper end of the inner cylinder.

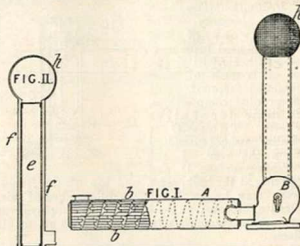

28,684. Robinson, E. Dec. 29. Drawings to Specification.

Heating air.—Air is drawn by a fan through a jacket surrounding the chimney of a rotary drying-furnace.

28,907. Day, C. G. Dec. 30.

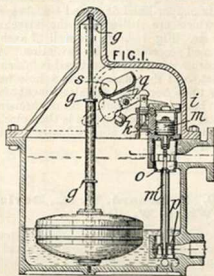

Steam traps.—The inlet and outlet valves *o, p* of a trap of the float type for draining pipes and condensers containing steam below atmospheric pressure are controlled by a piston *m* in a cylinder *i*. Steam is admitted to the upper or lower end of the cylinder by a piston valve *k*, which is operated through a lever *q* by collars *g* on the float spindle. When the piston *m* is in its highest position, steam passes from the cylinder into the trap and blows the water out. A rolling weight or tumbler *s* is fitted to the lever *q* to render its movements quicker. In a modification, the valve *p* is replaced by an ordinary non-return valve.

28,963. Hirst, H., and Cash, F. T.
Dec. 30.

Heating buildings; heating by electricity.—The framework of heat radiators used in connection with electricity, gas, or oil is made of wood rendered fireproof, or of fireproofed compositions, to secure decorative effects. Tubes C or similar passages extending from the rear of the reflecting-surface D and opening at the back, sides, and top of the frame work may be employed to diffuse heated air. Uralite, asbestos, or the like may be employed to protect the framework from injury by a gas or oil flame.

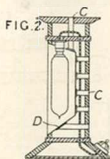

28,975. Paton, J. M. C., and Alliot, J. B. Dec. 30.

Boiling-pans; heating water.—Relates to improvements in vessels, apparatus, and the like employed in heating, steaming, or boiling operations, and consists in means for preventing the rusting which occurs in copper-lined or plated vessels around the holes which are drilled for the attachment of fittings &c. Fig. 1 shows the wall of such a vessel constructed according to the invention. A plug c of copper or non-rusting material is inserted in the iron plate a at the place where a hole has subsequently to be bored for the attachment of a fitting, its ends being swelled out to fill countersinkings in the plate. The whole surface is then electroplated as shown at b, and the plug is finally bored out and tapped as required.



29,139. Fritchard, W. M., Boyle, J. S., and White, W. Dec. 30.

Non-conducting coverings and compositions.—Asbestos is combined with the uppers and soles of boots and shoes to render them heat-resisting.

29,217. Griffith, P. G. Dec. 31.

Thermostats.—In an apparatus for sterilizing water, thermostats are used to allow the water to escape when sufficiently heated and to prevent overheating. The upper part of the heating-apparatus consists of a chamber f in which a water-outlet valve r is attached to a stirrup q pressing against a thermostatic capsule p so that when the latter expands the valve r opens and the water escapes. The water is preferably heated by a lamp u of the type in which petroleum vapour is forced

into the burner by compressed air. A thermostatic capsule z, when the temperature becomes too great, opens a valve x in a tube v communicating with the

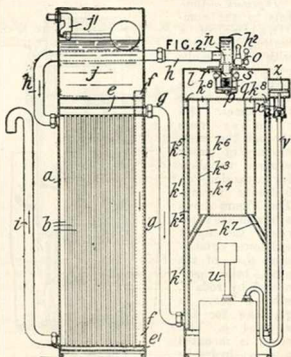

reservoir of the lamp u, thus releasing the pressure and extinguishing the lamp. The capsule z may contain distilled water or liquid boiling at a rather higher or lower temperature as may be required.

29,292. Clarkson, T. Dec. 31.

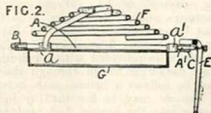
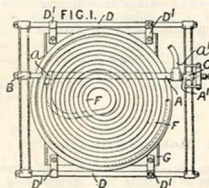

Thermostats.—Between a steam generator F and the liquid-fuel burner which heats it is placed a thermostatic regulator A, consisting of a tube connected at a to the generator F, and at a' to the steam-supply pipes, so that, as the length of the tube is varied by the temperature of the steam

passing through it, its free end A', sliding in the support C, operates the lever E for regulating the supply of liquid fuel. The supports B, C are mounted, preferably adjustably, on bars connected by rods D, which are connected by straps D' to the frame G carrying the boiler, so that the bars D do not become hot, and the distance B, C remains invariable.

29,349. Brader, C. Dec. 31.

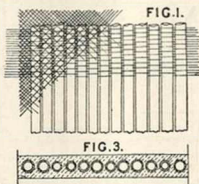

Non-conducting coverings.—Reeds arranged in layers are woven, bound, sewn, or otherwise attached to a flexible non-conducting material, such as asbestos, cork, peat fibre, felt, cloth, and the like. Or the reeds may be arranged in a plastic material, such as infusorial earth preferably mixed with a fibrous material, and have their exterior surfaces adapted to receive a protecting cover. Fig. 1 shows the reeds woven or embedded in an asbestos fabric. Fig. 3 shows in cross-section the reeds embedded in a plastic mass.

29,499. Pfahl, W. Dec. 31.

Heating water.—In a slow-combustion stove for heating water, in order to prevent gases from escaping through the fuel-door joints and other cracks when the air valves are shut at night, the fuel shaft *a* is provided with an upper chamber *e*, into which side flues *d*, of the form shown, open above the fuel. An opening *f*, in the rear wall of the fuel shaft communicates with flues *g* leading to the chimney.

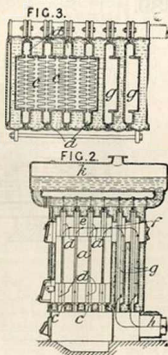

29,548. Foley, N. Dec. 31.

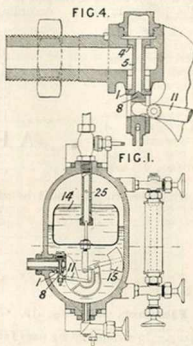

Steam traps.—In a steam trap of the float type, the discharge valve 1, Figs. 1 and 4, is fitted with a small relief valve 8, which admits water through the hollow spindle 5 to the top side of a piston 4, thereby equalizing the pressure on the under-side of the valve. The usual float is replaced by a heavy body 14, such as an open vessel filled with water, counterbalanced by a weight 15. The lever 11 acts first on the valve 8 and then on the valve 1. The inlet connection is shown at 25.

29,643. Sutcliffe, W. I. Dec. 31.

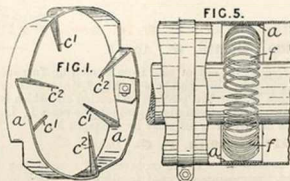

Non-conducting coverings.—Supporting-rings for non-conducting coverings of steam pipes, boilers, cylinders, and the like consist of a metal ring or band *a*, Fig. 1, with inwardly-projecting and alternately-arranged prongs *c*¹, *c*² formed by cutting the band diagonally. In a modification, a coiled wire *f*, Fig. 5, is employed with or without a surrounding

ring *a*. Instead of encircling the pipe, the coiled wire may be arranged in three or more lengths each with its axes at right-angles to the pipe in a manner similar to the prongs in Fig. 1. According to the

Provisional Specification, the projections in the first construction may be variously arranged and may be formed by the band being crimped or by the employment of an inner crimped ring.

APPENDIX.

The following abridgment should be added to those appearing on the volume of this Class for the period A.D. 1884-88.

A.D. 1884.

11,439. Fletcher, G. Aug. 19. *Drawings to Specification.*

Boiling-pans.—In steam-heating pans for cane juice, the inner pan is made of corrugated iron.

The following four abridgments should be added to those appearing in the volume of this Class for the period A.D. 1889-92.

A.D. 1889.

5869. Butlin, W. April 5.

Heating air.—Hot slag from a smelting furnace is run into the chambers *F*, Fig. 3, on trucks or bogies *K*, for the purpose of heating air, which is drawn into the chambers through the pipes *L*, *L'*. The heated air is led away by the pipes *M*.

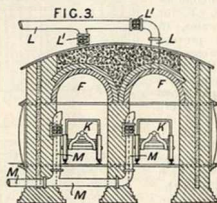

A.D. 1891.

13,553. Mitchell, W. Aug. 11.

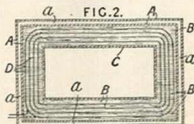

Heating by electricity.—Relates to ovens for cooking and heating purposes. The circuit wire D is wound around the ends and sides, top, bottom, and sides, or top, bottom, and ends of the oven casing C, between layers of asbestos or other non-conducting material B, enclosed within an outer casing A which may be jacketed as shown at a.

22,473. Drevo, C. Dec. 23.

Heating by electricity.—For warming air, two concentric insulating-cylinders A, B, Fig. 1, are mounted on a base C, the annular space between them being closed above by an arch. Spiral dovetail grooves a, b, Figs. 1, 3, and 3^a, are formed in the cylinders, and contain a series of metal pieces e of the shape shown. These pieces are held in place by springs c and studs. The current enters at m, passes through the metal pieces, sparking from one to another, and finally returns to n. The

high resistance of the circuit produces heat, thus causing a current of air to enter through openings g, h, the warmed air escaping at f'. The form of

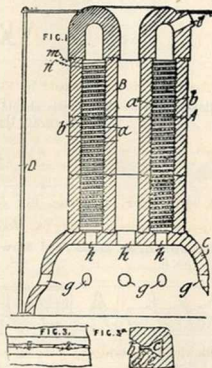

resistance may be varied. The parts of the stove are connected by tongues and grooves and are held in place by a frame D.

A.D. 1892.

7004. Wallace, A. April 12.

Heating by electricity.—For cooking, a revolving spit is fitted within an oven, in the walls of which electric conductors are placed and are heated by the passage of an electric current. One form of the apparatus is shown in Figs. 1 and 2. The spit 2 consists of a wire frame divided into compartments to receive chops &c., and is pivoted at the centre so that it may be revolved by hand or power. The lower chops are thus basted by the upper ones. A door is provided at 4 for obtaining access to the spit. Auxiliary heated chambers are provided at 8, 9 for heating plates &c. Other and larger forms are used for cooking joints &c., and electrically-heated rings are provided at the top in a similar manner to the rings of gas stoves.

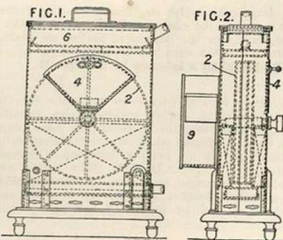

A.D. 1893.

The following sixteen abridgments should be added to those appearing in the volume of this Class for the period A.D. 1893-96.

259. Crompton, R. E. B., and Dowsing, H. J. Jan. 5.

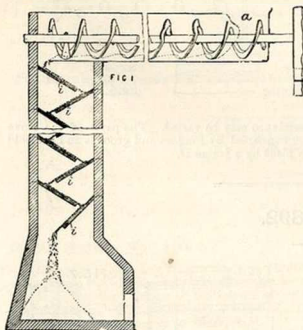

Heating by electricity.—In apparatus for the drying, roasting, &c. of paints, oxides, metallic ores, or chemicals, the materials are passed over shelves or surfaces which are heated electrically substantially in the manner described in Specification No. 17,091, A.D. 1892. The shelves are preferably arranged, as shown, on opposite sides of a vertical chamber, into the top of which the material is fed by means of a hopper *a* and worm,

6579. Mitchell, W. March 28.

Heating by electricity.—The front *B* of a radiator for heating rooms is formed with cylindrical openings *D* around which the heating-coils *G* are placed. The heating-coils consist preferably of layers of asbestos *h'* upon which the conductor *H* is wound. The room is heated by radiation from the apparatus, and also by the currents of air which pass up through the bottom and out through the cylindrical openings *D*.

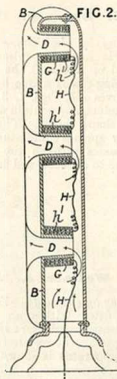

10,015. Crompton, R. E. B., and Dowsing, H. J. May 19.

Heating by electricity.—Electrically-heated plates for cooking are formed with corrugations, flutings, or projections to permit of the easy escape of steam

and moisture. In the form shown, a corrugated metallic heating surface *a*, Fig. 2, is combined

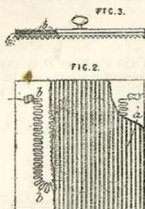

with an enamel backing in which the conductors *b* are embedded. The article being cooked may be covered with a lid, Fig. 3, which may be directly heated or not.

10,648. Mitchell, G. May 31.

Heating by electricity.—One or more incandescent or other electric lamps *a* are enclosed within glass tubes *b*, which communicate with a tube *d* provided with radiating-plates *e*. The tube *d* ends in a curved-portion *f*, which supports the lower ends of the tubes *b*. On the top of the apparatus is a glass sphere or cylinder *h* having a valve *i*. The tubes are filled with a liquid, such as glycerine, which may be coloured with aniline or other dye. The glycerine or other liquid becomes heated and circulates through the connected tubes.

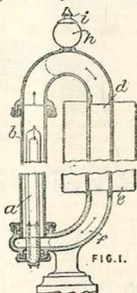

16,389. McElroy, J. F. Aug. 31.

Heating by electricity.—An apparatus for warming a room consists of a casing *A*, provided with a cap and having openings at the top and bottom; in it are placed cylinders *C* coated with non-conducting material, and carrying resistance coils *C*. The cylinders are carried by projections *P* on plates *R*, the upper and lower ends of the coils being electrically connected together by means of wires *W* and contact-rods *F*.

(For Figure see next column.)

16,389.

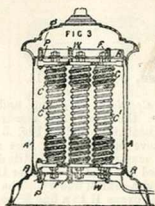

21,434. Schindler, F. W. Nov. 10.

Heating by electricity.—In an electrically-heated oven, one or more of the heating-plates, consisting of refractory material in which the conductors are embedded, are made adjustable. This may be effected by arranging a number of horizontal guide-rails in the oven or by means of mechanism consisting of a rack, which is connected to a frame *i* carrying the upper heating-plate *g*; the rack is movable between guides *k*, and is actuated by a pinion and fixed by means of a ratchet wheel and pawl. To permit of access to the conductor without opening the oven, a portion of it may extend into a chamber separated from the oven by a partition. In a modification, the plate is suspended from a pair of chains passing over rollers carrying ratchet &c. wheels.

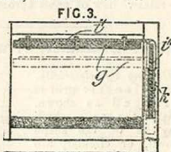

23,170. Miller, L. B., and Woods, M. W. Dec. 2.

Heating by electricity, transformers for. The secondary wire is bare, and a shifting contact is arranged to slide on it so that the electromotive force may be varied. Fig. 2 shows the arrangements. The ring transformer has the secondary *C* bare. *D* is the sliding contact or switch pivoted at *I*, and *J* represents the zero position. The transformer is especially useful for heating platinum wire cauteries for medical purposes.

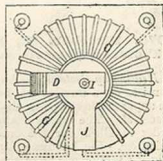

A.D. 1894.

13,615. Ross, J. H. July 14.

Heating by electricity.—Heating and cooking appliances have the flues &c. constructed to distribute the heat uniformly. Fig. 3 shows a section of a stove or kitchener. The source of heat T, which may consist of electrically-heated coils, is contained in a heating chamber D having a domed top F and a central flue F'. The hot gases pass through the ovens E to a flue E' beneath the floor and back to the heating chamber D. A circulation is thus maintained. A suitable chimney is fitted at D'. A valve G is arranged to regulate the relative flow of gases through the ovens For

heating purposes the chamber D is connected to suitable tubes or pipes for conveying the hot gases.

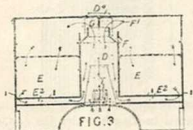

19,877. Schindler, F. W. Oct. 18.

Heating by electricity.—An electric grill is arranged as shown. Within the bars *a*, which may be of the shape shown, or circular, are arranged the heating-wires *b*. They are held in position by the inner plates *c*. The wires start from insulated blocks *d* arranged in the side frames, and are connected to the omnibus bars C, C'. Switches are provided that certain groups may be arranged in series or in

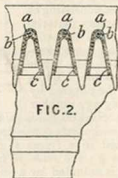

parallel. The dripping pan or gravy receiver *g* may also be fitted with a heater. The heater or

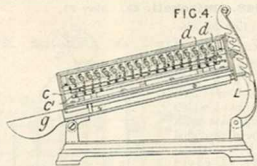

grill may be hinged to a suitable base and its inclination adjusted by the rack L.

A.D. 1895.

7075. Fletcher, T., Russell, W., and Fletcher, Russell, & Co. April 6.

Heating by electricity.—An apparatus for grilling consists of a number of bars each consisting of an upper and lower plate, the latter not being always essential. The upper plate slopes downward in order to allow for the drainage of melted fat, juice, &c. Fig. 1 shows a plan of the apparatus, and Fig. 3 a section of one of the bars. The bars A are cast or formed in groups of three joined together at one end B and suitably supported in a frame. Suitable gutters may be arranged to collect the fat &c. In a modified form, the bars are cast with or connected to the frame.

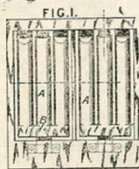

7319. Fletcher, T., Russell, W., and Fletcher, Russell, & Co. April 10.

Heating by electricity.—In order to increase the heat radiating surface and facilitate the escape of juices, melted fats, &c., electrically-heated hot-plates are provided with perforations B, the intermediate solid portions C being slightly convex or conical in cross-section and sloping towards the openings. The form and arrangement of the perforations and of the sloping parts may be varied.

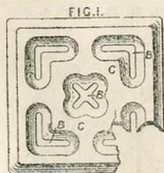

9372. Middleton, V. G., and Neale, D. May 11.

Heating by electricity.—An oven is formed in two parts 1, 1^a, the upper part being raised vertically to expose the contents. This upper part, suitably jacketed with insulating-material, is supported in a framework and counterbalanced to render it easily movable. The lower part 1^a carries a frame 12 fitted with ledges 12^a for carrying shelves. The oven is preferably heated by incandescent lamps 13, 13^a. The lamps are arranged in parallel, each having a separate switch, as 14, 16.

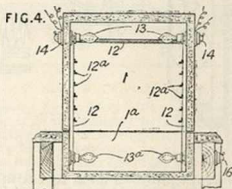

A.D. 1896.

1094. Cartland, G. H., and Ross, J. H. Jan. 16.

Heating by electricity.—Stoves are constructed with ornamental fronts imitative of frigates. The front and side casing is divided in a horizontal plane into two parts hinged at D, and ribs or bars F, G projecting inwardly, which are concealed when the upper part A of the front is in its normal position, constitute a horizontal grid over the source of heat for supporting cooking-utensils, hand-irons, &c.

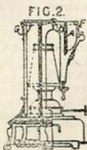

7318. Gold, E. E. April 4.

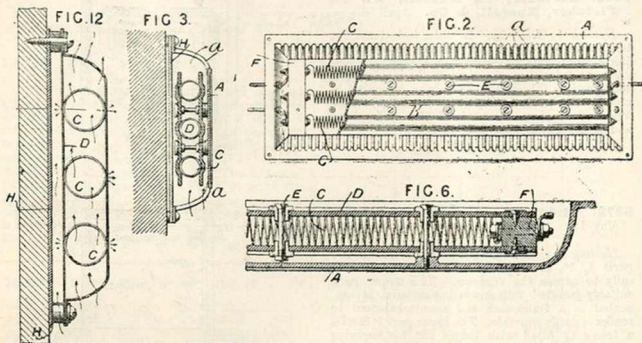

Heating by electricity.—A heater for electric cars, state rooms on steam ships, or other places is shown. Fig. 2 is a sectional elevation, Fig. 3 a cross-section, Fig. 6 a horizontal section (enlarged), and Fig. 12 a cross-section of a modification. Three resistance coils C are confined between two parallel supporting-plates D of insulating-material, forming between them a space for circulation of air. The coils are retained by longitudinal grooves in the plates D and are fastened at their ends to pieces F, to which the plates D are also attached.

The grip of the plates D on the coils is adjusted by insulated screws E. The heater is attached to a casing A, which is provided with air passages a and is separated from the wall by an asbestos sheet H. In Fig. 12, the casing A is dispensed with, the coils are supported by friction alone, and the plates D are of metal, coated with enamel or other insulating-substance. In a further modification, six superposed coils are provided, and any suitable switch may be employed for regulating the heat.

14,014. Dymond, G. C., [Chemisch-Elektrische Fabrik "Prometheus" Ges.]. June 24.

Heating by electricity.—Relates to cooking-apparatus, described with reference to saucopans, frying pans, vessels for heating milk, and roasting pans or ovens. Consists in using, as the conductors to be heated by the passage of the current, thin layers or strips of the precious metals formed on an enamel or other insulating-surface as in ceramic gold decoration. The vessels may be formed of metal coated with enamel &c. or made entirely of the

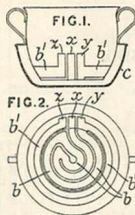

insulating-material, and

they are provided with protective casings carrying spring contact-devices. In the form shown in Figs. 1 and 2, the strips b are arranged spirally on the bottom of the vessel and the strips b' on the sides. Strips x, y, z make contact with springs carried by a casing c when the latter is placed in position.

28,567. Pearson, and Newton, G. E. Dec. 14.

Heating by electricity.—Into a suitable grate, stove, or brazier is placed a metal wire frame of similar shape but small size, leaving an annular space into which are packed irregularly-shaped pieces of coloured glass so as to give the effect of a glowing fire when an electric lamp is placed within the grate or brazier. The wire frame may be carried over the top of the receptacle so as to increase the area of the glowing surface.

The following seven abridgments should be added to those appearing in the volume of this Class for the period A.D. 1897-1900.

A.D. 1897.

4391. Heys, W. E., [Chedville, A. D.]. Feb. 18.

Heating by electricity.—A resistant wire B is wound on a notched sheet A of asbestos board, or on an asbestos tube. The ends of the resisting and connecting wires B, F are clinched by eyelets C. The sheet is then enclosed between two other asbestos boards D, which are attached with silicate of potash. A tube may be enclosed in another asbestos tube. The whole is then placed in a metal case, which may be of sheet metal D, folded and joined at its edges. Such heaters may be used in electric and other vehicles.

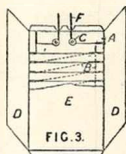

16,723. Edmunds, H. July 14.

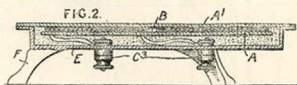

Heating by electricity.—Two copper or other plates A, A' are connected by a central distance-piece B, and one or more resistant wires, insulated with asbestos or otherwise, are wound spirally between them, the inner end of the wire being passed through a radial slot in the lower plate. The upper plate A' is fixed on a case E, which is filled up with cement, the wire being connected to terminals C. The case may be supported by layers of asbestos or other non-conductor, or by feet F.

17,070. Whiteley, W., [Holly, E. P.]. July 20.

Heating buildings.—In connection with steam power or heating plant a system is employed which establishes and utilizes a flow of steam for returning water of condensation and entrainment from a point below the water level in the generator back into the generator against the pressure therein. Fig. 1 shows the system as arranged for use with heaters and engines, the valves in the pipes being so located that the escaping water can be returned to the boiler either from the heaters or from engines using steam at the same or different pressures, or

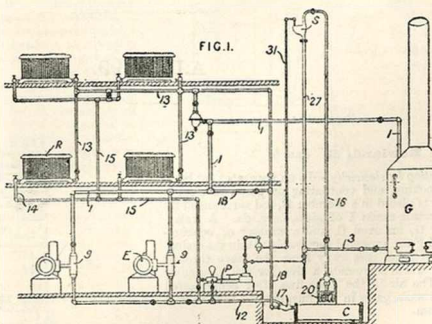

from both. The course of the steam and of the returning water according to one arrangement of valves is as follows:—Steam issuing from the boiler G passes along the pipes 1, 13 to the radiators R, and is taken by the pipes 14, 15 and the pump P to the receiver C. Steam which has passed to the separators 9 and the engines E escapes with entrained water by the pipes 12 to the receiver C. The returns are aided by the injection action of live steam which is conveyed by a pipe 18 to a nozzle opening to the box 17. From the receiver the water and steam ascend the pipe 16, separator S, downfall 27, and feed-pipe 3. The

pipe 31 may open to the atmosphere, so that steam escaping through a reducing valve may escape directly, or the pipe may lead to a pump P. The receiver C may be of any suitable construction, but is preferably a cylindrical tank with ordinary inlet, outlet, and blow-off perforations. The outlet is occupied by a pipe 20, having, within the cylinder, a vertically arranged series of orifices. It passes out through a stuffing-box with convenient screws for adjustment. The Specification also describes and illustrates the application of the system, with the necessary modifications, to heating-radiators only.

A.D. 1898.

7938. **Gourrier, A.** April 2.

Heating by electricity.—A device for re-heating or slowly cooking food is shown as applied to a gas stove, but is applicable to an electric heater. A plate *a* of copper, iron, earthenware, &c. is inserted between the stove *b* and the cooking-utensil *c*. The plate may be provided with a handle *d* and feet or clips *e*, and may be formed with perforations or with rings.

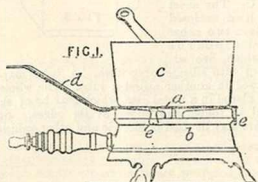

A.D. 1899.

341. **Rowland, E.** Jan. 6.

Heating by electricity.—In an apparatus for heating, cooking, and ventilating purposes, an electric heater is placed in a chamber B, and surrounded by a reflecting-shade I of glass, horn, &c. A water-heater G, an oven C, and a steamer or cooking-utensil F are arranged removably within the casing. The hot gases pass away from the stove through a flue which surrounds a flue for the passage of air. The air in the inner flue, after being heated by the waste gases in the flue, may be used to heat the room.

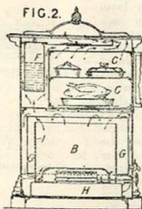

4124. **Dowsing, H. J.** Feb. 24.

Heating by electricity.—In an electric stove several elongated incandescent lamps *b* are situated in front of angularly-placed reflectors *d*, of bright copper or other metal, which with the back *e* of a casing form triangular channels in which air is heated and ascends below a forwardly-inclined top *g*. The invention is a modification of those described in Specifications No. 26,249, A.D. 1896, and No 4786, A.D. 1897. Safety fuses and switches for the lamps are provided in the casing *a*.

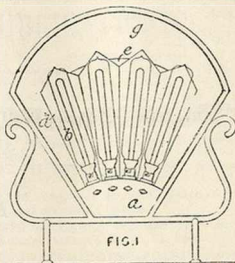

A.D. 1900.

11,579. **Woerner, F.** June 26.

Heating water ; thermostats.—The lateral expansion by the heat of steam of two bent tubes *a, a*, rigidly held at the top and bottom, is utilized to regulate the supply of steam used to heat a low-pressure boiler, or to operate a chimney damper. Fig. 10 shows an arrangement for operating a valve, damper, or other device by the rotation of a shaft *z*, which is mounted in bearings in a yoke *y* connected to one tube and turned by a hooked bar *b* attached to the other. A crank, rack and pinion, or other device may replace the hooked bar. Fig. 12 shows a low-pressure boiler heated by steam passed through a coil *E*, the supply of steam being controlled by a valve at *G* operated by the expansion of the tubes *a* when steam is admitted to them through the safety-valve *T*. Water from the stand-pipe *S* may be passed through the stay tube *F* to the bottom of the boiler.

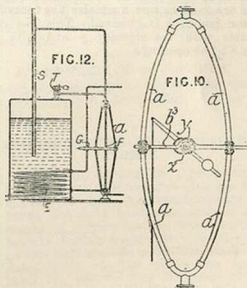

The following abridgment should be inserted on page 198 of the present volume.

A.D. 1903.

13,544. Gamondés, G. L. A. June 17.

Heating water.—Relates to a boiler which may be employed as a water heater for hot-houses, dwellinghouses, &c. A firebox *b* of circular cross-section, fixed on the centre of the bottom of the boiler shell *a*, also of circular cross-section, communicates with a door *d* in the shell. The wall of the firebox and its crown plate *c* are both corrugated. In the boiler walls, a horizontal ring *i* is fixed somewhat above the firebox *b*. From the wall of the firebox *b*, a ring *l* projects outwards, and to these two rings *i*, *l* circular corrugated walls *h* are fixed, so that a circular flue concentric with the firebox *b* is obtained. This flue communicates with the chimney *g* and with the firebox *b* by an opening *e*.

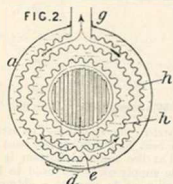
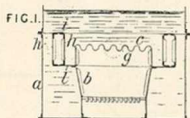



PATENT OFFICE PUBLICATIONS.

ACTS AND RULES.

Patents, Designs, and Trade Marks Act, 1883. 1s. 7½d., by post 1s. 9d.
Patents, Designs, and Trade Marks (Amendment) Act, 1885. 1½d., by post 2d.
Patents Act, 1886. 1½d., by post 2d.
Patents, Designs, and Trade Marks Act, 1888. 1½d., by post 2d.
Patents Act, 1901. ½d., by post 1d.
Patents Act, 1902. ½d., by post 1d.
Trade Marks Act, 1905. 3d., by post 4d.
Patents Rules, 1903. 6d., by post 7d.
Patents Rules, 1905. 1d., by post 1½d.
Designs Rules, 1890. 6d., by post 6½d.
Designs Rules (Lace), 1893. 1d., by post 1½d.
Designs Rules, 1898. 1d., by post 1½d.
Trade Marks Rules, 1906. 5d., by post 6½d.
Register of Patent Agents' Rules, 1889 and 1891. 2d., by post 2½d.

JOURNALS.

ILLUSTRATED OFFICIAL JOURNAL (PATENTS). Published every Wednesday. 6d., by post 8d. Annual Subscription, including postage, 1l. 15s.; Quarterly Subscription, 8s. 3d. CONTENTS:—Official Notices—Applications for Patents—Acceptances of Specifications—Amendments of Specifications—Patents Sealed—Renewal Fees Paid—Patents Void—Applications Abandoned &c.—Specifications &c. Published—Designs Registered—Illustrated Abridgments of Current Specifications—and Reports of Patent &c. Cases.

TRADE MARKS JOURNAL. Published every Wednesday. 6d., by post 8d. Annual Subscription, including postage, 1l. 15s. Quarterly Subscription, 8s. 9d. CONTENTS:—Illustrations of Trade Marks applied for, and the Names and Callings of Applicants.

1876-1887. Nos. 1 to 500. 1s. each.
1888. Nos. 510 to 561. 1s. 6d. each.
1889-1905. Nos. 562 to 1448. 6d. each, by post 8d.

Subscriptions to the above Journals will not be received for a shorter period than three months, such period to commence on either of the following dates:—

1st January,	1st July, or
1st April,	1st October.

Annual Subscriptions to date from 1st January in each year.

153,000—Wt. 6,368—1906—L. & M., Ltd.

REPORTS of PATENT, DESIGN, and TRADE MARK CASES.

1884-6. 6d. each number, or 10s. per yearly volume.
1887-8. 1s. each number, or 20s. per yearly volume.
1889-1905. 6d. each number. Price of yearly volumes according to size.

DIGESTS of CASES reported in Vols. L-V. 1s. each; Vols. VI-XXII, 6d. each.

CONSOLIDATED DIGEST of CASES reported in Vols. I-X., 5s. per copy, by post 5s. 5d.; Vols. XI-XVI., 5s. per copy, by post 5s. 4d.

PRINTED SPECIFICATIONS OF PATENTS. 1617-1906.

Price per copy, 8d., including inland postage. In ordering Specifications the Name of the Patentee, and the Number and Year of the Patent must be given. Specifications are on Sale 15 days after Advertisement of Acceptance of Complete Specification.

ABRIDGMENT CLASS AND INDEX KEY (issued December, 1899).

Showing ABRIDGMENT CLASSES and INDEX HEADINGS, to which Inventions are assigned in the Official Publications of the Patent Office. 1s., by post 1s. 6d.

APPENDIX (issued June, 1905).

Showing additions and alterations in the ABRIDGMENT CLASS AND INDEX KEY. 1s., by post 1s. 4d.

ABRIDGMENTS OF SPECIFICATIONS.

(A).—Illustrated volumes of Abridgments of Specifications in accordance with the classification in the ABRIDGMENT-CLASS AND INDEX KEY have been published, or are in course of preparation, for ten consecutive periods, dealing completely with all specifications published from 1617 to the present date. There are 146 volumes for each of these ten periods, and the price of each volume is 1s., including inland postage.

List of Illustrated Volumes.

1. ACIDS, ALKALIES, OXIDES, AND SALTS, INORGANIC.
2. ACIDS AND SALTS, ORGANIC, AND OTHER CARBON COMPOUNDS, [including Dyes].
3. ADVERTISING AND DISPLAYING.
4. AERONAUTICS.
5. AGRICULTURAL APPLIANCES, FARMYARD AND LIKE, [including the housing, feeding, and treatment of animals].
6. AGRICULTURAL APPLIANCES FOR THE TREATMENT OF LAND AND CROPS, [including Gardening-appliances].



ii PATENT OFFICE PUBLICATIONS.

7. AIR AND GAS ENGINES.
8. AIR AND GASES, COMPRESSING, EXHAUSTING, MOVING, AND OTHERWISE TREATING.
9. AMMUNITION, TORPEDOES, EXPLOSIVES, AND PYRO-TECHNICS.
10. ANIMAL-POWER ENGINES AND MISCELLANEOUS MOTORS.
11. ARTISTS' INSTRUMENTS AND MATERIALS.
12. BEARINGS AND LUBRICATING-APPARATUS.
13. BELLS, GONGS, FOGHorns, SIRENS, AND WHISTLES.
14. BEVERAGES, [excepting Tea, coffee, cocoa, and like beverages].
15. BLEACHING, DYEING, AND WASHING TEXTILE MATERIALS, YARNS, FABRICS, AND THE LIKE, [excepting Dyes].
16. BOOKS, [including Cards and card cases and the like].
17. BOOTS AND SHOES.
18. BOXES AND CASES, [excepting Trunks, portmanteaus, hand and like travelling bags, baskets, hampers, and other wickerwork].
19. BRUSHING AND SWEEPING.
20. BUILDINGS AND STRUCTURES.
21. CASES AND BARRELS.
22. CEMENTS AND LIKE COMPOSITIONS.
23. CENTRIFUGAL DRIVING, SEPARATING, AND MIXING MACHINERY AND APPARATUS.
24. CHAINS, CHAIN CABLES, SHACKLES, AND SWIVELS.
25. CHIMNEYS AND FLUES, [including Ventilating-shaft tops].
26. CLOSETS, URINALS, BATHS, LAVATORIES, AND LIKE SANITARY APPLIANCES.
27. COIN-FREED APPARATUS AND THE LIKE.
28. COOKING AND KITCHEN APPLIANCES, BREAD-MAKING, AND CONFECTIONERY.
29. COOLING AND ICE-MAKING, [including Refrigerators and Ice-storing].
30. CUTLERY.
31. CUTTING, PUNCHING, AND PERFORATING PAPER, LEATHER, AND FABRICS, [including the general treatment of paper after its manufacture].
32. DISTILLING, CONCENTRATING, EVAPORATING, AND CONDENSING LIQUIDS, [excepting Steam-engine condensers].
33. DRAINS AND SEWERS.
34. DRYING.
35. DYNAMO-ELECTRIC GENERATORS AND MOTORS, [including Frictional and influence machines, magnets, and the like].
36. ELECTRICITY, CONDUCTING AND INSULATING.
37. ELECTRICITY, MEASURING AND TESTING.
38. ELECTRICITY, REGULATING AND DISTRIBUTING.
39. ELECTRIC LAMPS AND FURNACES.
40. ELECTRIC TELEGRAPHS AND TELEPHONES.
41. ELECTROLYSIS, [including Electrodeposition and Electroplating].
42. FABRICS, DRESSING AND FINISHING WOVEN AND MANUFACTURING FELTED, [including Folding, Winding, Measuring, and Packing].
43. FASTENINGS, DRESS, [including Jewellery].
44. FASTENINGS, LOCK, LATCH, BOLT, AND OTHER, [including Safes and strong-rooms].
45. FENCING, TRIBLES, AND WIRE NETTING.
46. FILTERING AND OTHERWISE PURIFYING LIQUIDS.
47. FIRE, EXTINCTION AND PREVENTION OF.
48. FISH AND FISHING.
49. FOOD PREPARATIONS AND FOOD-PRESERVING.
50. FUEL, MANUFACTURE OF.
51. FURNACES AND KILNS, [including Blowpipes and blowpipe burners; Smiths' forges and rivet hearths; and Smoke and fumes, Treating].
52. FURNITURE AND UPHOLSTERY.
53. GALVANOTYPERS.
54. GAS DISTRIBUTION.
55. GAS MANUFACTURE.
56. GLASS.
57. GOVERNORS, SPEED-REGULATING, FOR ENGINES AND MACHINERY.
58. GRAIN AND SEEDS, TREATING, [including Flour and meal].
59. GRINDING OR ABRADING, AND BURNISHING, AND THE LIKE.
60. GRINDING OR ABRADING, AND BURNISHING.
61. HAND TOOLS AND BENCHES FOR THE USE OF METAL, WOOD, AND STONE WORKERS.
62. HARNESS AND SADDLERY.
63. HATS AND OTHER HEAD COVERINGS.
64. HEATING, [excepting Furnaces and kilns; and Stoves, ranges, and fireplaces].
65. HINGES, HINGE-JOINTS, AND DOOR AND GATE FURNITURE AND ACCESSORIES, [excepting Fastenings, Lock, latch, bolt, and other].
66. HOLLOW-WARE, [including Buckets, Pans, Kettles, Saucepans, and Water-cans].
67. HORSE-SHOES.
68. HYDRAULIC ENGINEERING.
69. HYDRAULIC MACHINERY AND APPARATUS, [excepting Pumps, and other means for raising and forcing liquids].
70. INDIA-RUBBER AND GUTTA-PERCHA, [including Plastic compositions and Materials of constructive utility, other than metals and stone].
71. INJECTORS AND EJECTORS.
72. IRON AND STEEL MANUFACTURE.
73. LABELS, BADGES, COINS, TOKENS, AND TICKETS.
74. LACE-MAKING, KNITTING, NETTING, BRAIDING, AND PLAITING.
75. LAMPS.
76. LAMP, CANDLESTICKS, GASOLINES, AND OTHER ILLUMINATING APPARATUS, [excepting Electric lamps].
76. LEATHER, [including Treatment of hides and skins].
77. LIFE-SAVING, [MARINE], AND SWIMMING AND BATHING APPLIANCES.
78. LIFTING, HAULING, AND LOADING, [including Lowering, Winding, and Unloading].
79. LOCOMOTIVES AND MOTOR VEHICLES FOR ROAD AND RAIL, [including Portable and semi-portable engines].
80. MECHANISM AND MILL GEARING.
81. MEDICINE, SURGERY, AND DENTISTRY.
82. METALS AND ALLOYS, [excepting Iron and Steel manufacture].
83. METALS, CUTTING AND WORKING.
84. MILKING, CHURNING, AND CHEESE-MAKING.
85. MINING, QUARRING, TUNNELLING, AND WELL-SINKING.
86. MIXING AND AGITATING MACHINES AND APPLIANCES, [excepting Centrifugal machines and apparatus].
87. MOULDING PLASTIC AND POWDERED SUBSTANCES, [including Bricks, building and paving blocks, and tiles, and Pottery].
88. MUSIC AND MUSICAL INSTRUMENTS.
89. NAILS, RIVETS, BOLTS AND NUTS, SCREWS AND LIKE FASTENINGS.
90. NON-METALLIC ELEMENTS.
91. OILS, FATS, LUBRICANTS, CANDLES, AND SOAPS.
92. ORDNANCE AND MACHINE GUNS.
93. ORNAMENTS.
94. PACKING AND Baling GOODS.
95. PAINTS, COLOURS, AND VARNISHES.
96. PAPER, PASTEBOARD, AND PAPER MACHÉ.
97. PHILOSOPHICAL INSTRUMENTS, [including Optical, Nautical, Surveying, Mathematical, and Meteorological Instruments].
98. PHOTOGRAPHY.
99. PIPES, TUBES, AND HOSE.
100. PRINTING, LETTERPRESS AND LITHOGRAPHIC.
101. PRINTING OTHER THAN LETTERPRESS OR LITHOGRAPHIC.
102. PUMPS AND OTHER MEANS FOR RAISING AND FORCING LIQUIDS, [excepting Rotary Pumps].
103. RAILWAY AND TRAMWAY VEHICLES.
104. RAILWAYS AND TRAMWAYS.
105. RAILWAY SIGNALS AND COMMUNICATING-APPARATUS.
106. REGISTERING, INDICATING, MEASURING, AND CALCULATING, [excepting Signalling and indicating by signals].
107. ROADS AND WAYS.
108. ROAD VEHICLES.
109. ROPES AND CORDS.
110. ROTARY ENGINES, PUMPS, BLOWERS, EXHAUSTERS, AND METERS.
111. SEWAGE, TREATMENT OF, [including Manure].
112. SEWING AND EMBROIDERING.
113. SHIPS, BOATS, AND RAFTS, Div. I.
114. _____ Div. II.
115. _____ Div. III.
116. SHOP, PUBLICHOUSE, AND WAREHOUSE FITTINGS AND ACCESSORIES.
117. SIFTING AND SEPARATING.
118. SIGNALING AND INDICATING BY SIGNALS, [excepting Railway signals and communicating-apparatus].
119. SMALL-ARMS.
120. SPINNING, [including the preparation of fibrous materials and the doubling of yarns and threads].
121. STARCH, GUM, SIZE, GLUE, AND OTHER STIFFENING AND ADHESIVE MATERIALS.
122. STEAM ENGINES, [including Details common to fluid-pressure engines generally].
123. STEAM GENERATORS, [excepting Furnaces].
124. STONE, MARBLE, AND THE LIKE, CUTTING AND WORKING.
125. STOPPING AND BOTTLING, [including Bottles, jars, and like vessels].
126. STOVES, RANGES, AND FIREPLACES.
127. SUGAR.
128. TABLE ARTICLES AND APPLIANCES.
129. TEA, COFFEE, COCOA, AND LIKE BEVERAGES.
130. TOBACCO.
131. TOILET AND HAIRDRESSING ARTICLES, AND PERFUMERY.
132. TOYS, GAMES, AND EXERCISERS.
133. TRUNKS, PORTMANTEAUS, HAND AND LIKE TRAVELLING BAGS, BASKETS, HAMPERS, AND OTHER WICKERWORK.
134. UMBRELLAS, PARASOLS, AND WALKING-STICKS.
135. VALVES AND COCKS.

136. VELOCIPEDES.
137. VENTILATION.
138. WASHING AND CLEANING CLOTHES, DOMESTIC ARTICLES, AND BUILDINGS.
139. WATCHES, CLOCKS, AND OTHER TIMEKEEPERS.
140. WATERPROOF AND SIMILAR FABRICS.
141. WEARING-APPAREL.
142. WEAVING AND WOVEN FABRICS.
143. WEIGHING-APPARATUS.
144. WHEELS FOR VEHICLES, [excepting Wheels for Locomotives and tramway and traction engines; Railway and tramway vehicles; and Toys].
145. WOOD AND WOOD-WORKING MACHINERY.
146. WRITING-INSTRUMENTS AND STATIONERY AND WRITING ACCESSORIES, [including Educational appliances].

List of Periods.

- 1617-1854. (*In preparation.*)
1855-1866.
1867-1870.
1877-1883.
1884-1889.
1889-1890.
1893-1899.
1897-1900.
1901-1904.
1905-1908. (*In preparation.*)

NOTICE.—Volumes in course of publication can be obtained sheet by sheet, as printed, by payment in advance of a subscription of 2s. for each volume, including inland postage. The sheets already printed can be seen in the Patent Office Library and in some of the principal provincial Libraries.

- (B).—Unillustrated volumes of Abridgments of Specifications from 1617 to 1866. For the period before 1855, reference may be made to the unillustrated series of abridgments, but it must be borne in mind that this series is not in accordance with the above classification and does not deal completely with all the published specifications belonging to that period. The price of each volume in this series is 2s., including inland postage.

List of Unillustrated Volumes.

(The numbers within brackets following the titles are the serial numbers of the volumes).

- ACIDS, ALKALIES, OXIDES, AND SALTS:—(40.) 1622-1866.
AERONAUTICS. (41.) 1815-1866.
AGRICULTURE:—
—Div. I.—FIELD IMPLEMENTS. (81.) 1618-1866.
—Div. II.—BARN AND FARMYARD IMPLEMENTS, [including the cleansing, drying, and storing of grain]. (82.) 1636-1866.
—Div. III.—AGRICULTURAL AND TRACTION ENGINES. (83.) 1618-1866.
AIDS TO LOCOMOTION. (7.) 1691-1856.
AIR, GAS, AND OTHER MOTIVE-POWER ENGINES. (62.) 1636-1866 (*out of print*).
ANCHORS. (63.) 1796-1866.
ARTIFICIAL LEATHER, FLOORCLOTH, OILCLOTH, OILSKIN, AND OTHER WATERPROOF FABRICS. (80.) 1827-1866.
ARTISTS' INSTRUMENTS AND MATERIALS. (61.) 1618-1866.
BLEACHING, DYEING, AND PRINTING CALICO AND OTHER FABRICS AND YARNS. (41.) 1617-1857.
BOOKS, PORTFOLIOS, CARD-CASES, &c. (43.) 1768-1866.
BREWING, WINE-MAKING, AND DISTILLING ALCOHOLIC LIQUIDS. (60.) 1631-1856.

- BRICKS AND TILES. (22.) 1619-1860.
BRIDGES, VIADUCTS, AND AQUEDUCTS. (26.) 1730-1866.
BRUSHING AND SWEEPING. (57.) 1699-1866.
CARRIAGES AND OTHER VEHICLES FOR COMMON ROADS. (68.) 1625-1866.
CARRIAGES AND OTHER VEHICLES FOR RAILWAYS. (46.) 1807-1866.
CARBS AND BARBERS. (74.) 1757-1866.
CHAINS, CHAIN CABLES, &c. (90.) 1634-1866.
COOKING, BREAD-MAKING, AND CONFECTIONERY. (45.) 1631-1866.
CUTTING, FOLDING, AND ORNAMENTING PAPER. (12.) 1636-1866.
DRAINS AND SEWERS. (1.) 1619-1866.
DRESSING AND FINISHING WOVEN FABRICS, AND MANUFACTURING FELTED FABRICS. (51.) 1619-1866.
ELECTRICITY AND MAGNETISM, THEIR GENERATION AND APPLICATIONS. (15.) 1706-1817.
—Div. IV.—ELECTRIC LIGHTING, IGNITION, AND HEATING. (93.) 1839-1876 (*out of print*).
—Div. V.—ELECTRODEPOSITION AND ELECTROLYSIS. (94.) 1805-1876.
—Div. VI.—ELECTRIC MOTIVE-POWER ENGINES AND SIMILAR APPARATUS. (67.) 1837-1876.
FABRICRY. (53.) 1719-1866.
FIRE-ARMS AND OTHER WEAPONS, AMMUNITION, AND ACCOUTREMENTS. (40.) 1588-1858.
FIRE ENGINES, EXTINGUISHERS, ESCAPES, ALARMS, &c. (58.) 1625-1866.
FURNITURE AND UPHOLSTERY. (30.) 1620-1866.
GRINDING GRAIN, AND DRESSING FLOUR AND MEAL. (78.) 1625-1866.
HARBOURS, DOCKS, CANALS, &c. (77.) 1617-1866.
HINGES, HINGE-JOINTS, AND DOOR SPRINGS. (3.) 1775-1866.
HYDRAULICS. (32.) 1617-1866.
ICE-MAKING MACHINES, ICE SAFES, AND ICE HOUSES. (65.) 1812-1866.
LACE-MAKING, KNITTING, NETTING, BRAIDING, AND PLAITING. (29.) 1675-1866.
LAMPS, CANDLESTICKS, CHANDELIERS, AND OTHER ILLUMINATING APPARATUS. (44.) 1657-1866.
LETTERPRESS AND SIMILAR PRINTING. (13.) 1617-1857.
LOCKS, LATCHES, BOLTS, AND SIMILAR FASTENINGS. (63.) 174-1866.
MANUFACTURE OF IRON AND STEEL. (6.) 1620-1826.
MANUFACTURE OF PAPER, PASTEBOARD, AND PAPER MACHE. (11.) 1665-1857.
MANURE. (5.) 1721-1866.
MARINE PROPULSION, [excepting Sails]. (5.) 1618-1857.
MASTS, SALES, RIGGING, &c. (73.) 1615-1866.
MEDICINE, SURGERY, AND DENTISTRY. (25.) 1620-1866.
METALLIC PIPES AND TUBES. (70.) 1741-1866.
METALS AND ALLOYS, [excepting Iron and Steel]. (48.) 1623-1859.
MILKING, CHURNING, AND CHEESE-MAKING. (72.) 1777-1866.
MINING, QUARRYING, TUNNELLING, AND WELL-SINKING. (11.) 1618-1866.
MUSIC AND MUSICAL INSTRUMENTS. (26.) 1691-1866.
NAILS, RIVETS, BOLTS, SCREWS, NUTS, AND WASHERS. (58.) 1618-1866.
NEEDLES AND PINS. (45.) 1755-1866.
OILS, FATS, LUBRICANTS, CANDLES, AND SOAPS. (67.) 1617-1866.
OPTICAL, MATHEMATICAL, AND OTHER PHILOSOPHICAL INSTRUMENTS. (76.) 1636-1866.
PAINTS, COLOURS, AND VARNISHES. (50.) 1618-1866.
PHOTOGRAPHY. (19.) 1838-1859.
PLATING OR COATING METALS WITH METALS. (23.) 1637-1866.
POTTERY. (34.) 1626-1861.
PREPARATION AND COMBUSTION OF FUEL. (30.) 1620-1865 (*out of print*).
PREPARATION AND USE OF TOBACCO. (42.) 1721-1866.
PREPARATION OF INDIA-RUBBER AND GUTTA-FERRECHA. (18.) 1794-1866.
PREPARING AND CUTTING CORK, BOTTLING LIQUIDS, &c. (66.) 1777-1866.
PRESERVATION OF FOOD. (4.) 1691-1855.
PRODUCTION AND APPLICATIONS OF GAS. (17.) 1681-1858.
PURIFYING AND FILTERING WATER. (79.) 1675-1866.
RAILWAYS. (53.) 1807-1866.
RAILWAY SIGNALS AND COMMUNICATING APPARATUS. (38.) 1840-1866 (*out of print*).
RAISING, LOWERING, AND WEGGING. (31.) 1617-1866.
ROADS AND WAYS. (55.) 1610-1866.
SADDLERY, HARNESS, STABLE FITTINGS, &c. (34.) 1625-1866.
SAFES, STRONG ROOMS, TILLS, &c. (64.) 1801-1866.
SEWING AND EMBROIDERING. (2.) 1755-1866.
SHIP BUILDING, REPAIRING, SHEATHING, LAUNCHING, &c. (21.) 1618-1866.
SKINS, HIDE, AND LEATHER. (55.) 1627-1866.
SPINNING. (28.) 1621-1865 (*out of print*).
STARCH, GUM, SIZE GLUE, &c. (100.) 1717-1876.
STEAM CULTURE. (8.) 1618-1856. (See also AGRICULTURE Divs. I. and III.)

STEAM ENGINES. (49.) 1618-1859 (in 2 vols.).
STEERING AND MANŒUVRING VESSELS. (75.) 1763-1866.
SUGAR. (48.) 1833-1866.
TEA, COFFEE, CHICORY, CHOCOLATE, COCOA, &c. (87.) 1704-1866.
TOYS, GAMES, AND EXERCISES. (51.) 1672-1866.
TRUNKS, FORTMANTEAUS, BOXES, AND BAGS. (84.) 1685-1866.
UMBRELLAS, PARASOLS, AND WALKING-STICKS. (47.) 1786-1866.
UNFERMENTED BEVERAGES, AERATED LIQUIDS, MINERAL WATERS, &c. (96.) 1774-1866.
VENTILATION. (52.) 1632-1866.
WASHING AND WRINGING MACHINES. (89.) 1691-1866.
WATCHES, CLOCKS, AND OTHER TIMEKEEPERS. (9.) 1651-1866.
WATER CLOSETS, EARTH CLOSETS, URINALS, &c. (63.) 1775-1866.
WEARING-APPAREL.—DIV. I.—HEAD COVERINGS. (65.) 1837-1866.
—DIV. II.—BODY COVERINGS. (66.) 1671-1866.
—DIV. III.—FOOT COVERINGS. (67.) 1693-1866.
—DIV. IV.—DRESS FASTENINGS AND JEWELLERY. (68.) 1631-1866.
WEAVING. (20.) 1620-1866.
WRITING INSTRUMENTS AND MATERIALS. (37.) 1635-1866.

INDEXES.

1617-1852.

NAME INDEX. 5s., by post 5s. 6d.
SUBJECT-MATTER INDEX. 2 vols. 10s., by post 10s. 10d.

1852-1883.

NAME-INDEX.
1852-56, 1864-70. 2s. 6d. each yearly volume, by post 2s. 10d.
1871-1873. 2s. each yearly volume, by post 2s. 3d.
1877-83, 1874-83. *Out of print.*

SUBJECT-MATTER INDEX.
1852-1855. 5s. each yearly volume, by post 5s. 4d.
1856-1883. *Out of print.*

1884 and subsequent years.

NAME-INDEX.
1884. *Out of print.*
1885-1888. 2s. each yearly volume, by post 2s. 4d. 1887 *out of print.*
1889-1905. See Illustrated Official Journals, Nos. 52, 108, 160, 212, 255, 317, 370, 423, 475, 527, 579, 631, 683, 735, 787, 838, and 891. 6d. each, by post 8d. Journals Nos. 108, 160, and 212, *out of print.*

NUMBER-INDEX OF PROCEEDINGS ADVERTISED ON COMPLETE SPECIFICATIONS AND PATENTS. 1901-1905. See Illustrated Official Journals Nos. 687, 739, 790, 842, and 894. 6d. each, by post 8d.

SUBJECT-MATTER INDEX OF ACCEPTED COMPLETE SPECIFICATIONS DATED IN THE YEARS NAMED.

1884. 7s., by post 7s. 5d.
1885-1886. *Out of print.*
1887-1890. 3s. 4d. each yearly volume, by post 3s. 8d.
1891-1901. 2s. each yearly volume, by post 2s. 3d.

MONTHLY SUBJECT-MATTER INDEX OF ACCEPTED COMPLETE SPECIFICATIONS.
Consolidated in March, June, September, and December. 1s. each part. Annual Subscription, 5s., by post 7s. 6d.

NOTICE.—The above publications are sold at the PATENT OFFICE, 25, Southampton Buildings, Chancery Lane, W. C., and will be forwarded by post on receipt of the price and of the postage when such is charged. All Subscriptions must be paid in advance. Sums amounting to 1s. or more must be remitted by Postal or Post Office Order, payable to the CONTROLLER-GENERAL, at the above address. Cheques will not be accepted. Deposit accounts may be opened, the minimum deposit being £2.

PATENT OFFICE LIBRARY.

CATALOGUE.

- Vol. I. Authors. 1898. 1l. 6s. 0d.; by post 1l. 6s. 8d.
Vol. II. Subjects. 1883. 15s. 8d.; by post, 16s. 2d.
(New edition in preparation.)

GUIDES.

- 6d. each, including inland postage.
- Key to Classification of Patent Specifications of France, Germany, Austria, Norway, Denmark, Sweden, and Switzerland. 2nd Edition, 1905.
 - Fine and Graphic Arts (including Photography) and Art Industries. Subject List. 2nd Edition.
 - Laws of Industrial Property and Copyright. Subject List.
 - Guide to the Search Department of the Patent Office Library. With Appendices. 2nd Edition.
 - Key to the German Patent Classification, 1900. (For revised Classification, dated 1904, see No. 1 above.)
 - Chemistry and Chemical Technology. Subject List.
 - Chemical Industries, including Destructive Distillation, Mineral Oils and Waxes, Gaslighting, Acetylene; Oils, Fats, Soaps, Candles, and Perfumery; Paints, Varnishes, Gums, Resins; Paper and Leather Industries. Subject List.
 - Class List and Index to the Periodical Publications in the Patent Office Library. 2nd Edition.
 - Domestic Economy, Foods, and Beverages; including the Culture of Cacao, Coffee, Barley, Hops, Sugar, Tea, and the Grape. Subject List.
 - Textile Industries and Wearing-apparel; including the Culture and Chemical Technology of Textile Fibres. Subject List.
 - General Science, Physics, Sound, Music, Light, Microscopy, and Philosophical Instruments. Subject List.
 - Architecture and Building Construction. Subject List.
 - Mineral Industries and Allied Sciences. Subject List.
 - Electricity, Magnetism, and Electro-Technics. Subject List.
 - Agriculture, Rural Economy, and Allied Sciences. Subject List.
 - Heat and Heat Engines, (excluding Marine Engineering). Subject List.
 - Aerial Navigation and Meteorology. Subject List. Others in preparation.



ULTIMHEAT[®]
VIRTUAL MUSEUM



ULTIMHEAT®
VIRTUAL MUSEUM